

---

# **Economia Circolare ed Imballaggio**

*Le attività di ricerca al Consiglio Nazionale delle Ricerche*

---

**Salvatore Iannace**

*Istituto per lo Studio delle Macromolecole (ISMAC)*

*Consiglio Nazionale delle Ricerche, Milano*

**CNR-ISMAC**



# Istituto per lo Studio delle Macromolecole

**ISMAC** is an Institute of the National Research Council of Italy (CNR)

Main research activities: a) Synthesis of new macromolecules, b) chemical modification/functionalization of synthetic and natural macromolecules, c) assembling of macromolecules, d) processing technologies

**Biella**, RUOS C. Tonin



**Genova**, RUOS P. Stagnaro

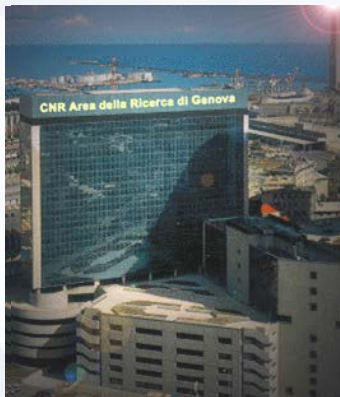

**Milano**, Director S. Iannace

[www.ismac.cnr.it](http://www.ismac.cnr.it)

Around **100** people :

**40** researchers, **30** postdoc , and PhD students, **28** technicians and adiminsitratives

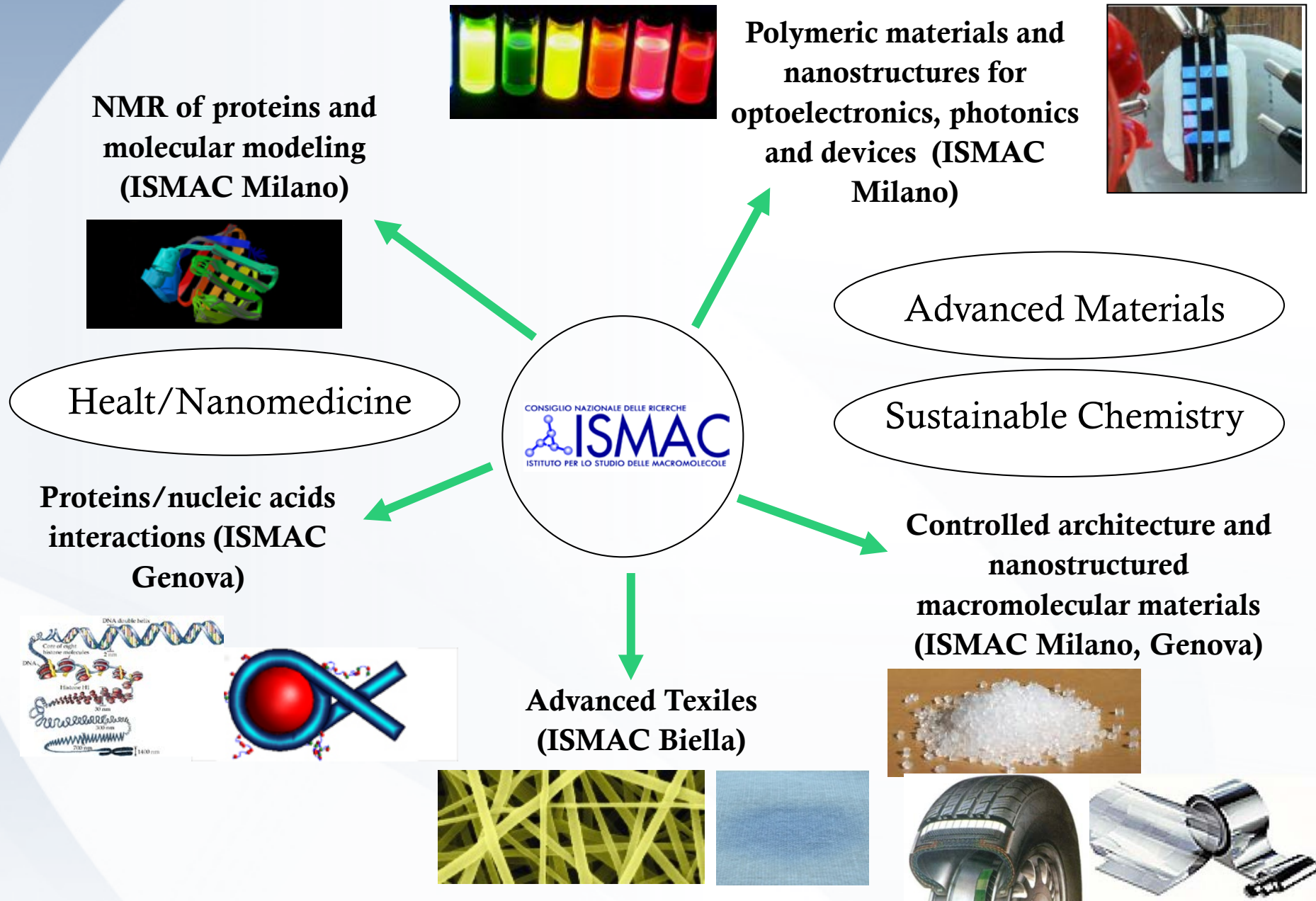

# The National Research Council - Basic Data



CNR is the largest Italian public research organization

1923: Year of foundation

Head of CNR: Prof. Massimo Inguscio

20 Research Centers and 105 Institutes, performing research activities and developing capabilities, coordinated by 7 Departments (Macro-Areas )

- \* *Chemical Sciences and Technology of Materials (DSCTM)*
- \* *Physical Sciences and Technologies of Matter (DSFTM)*
- \* *Earth System Sciences and Technologies for the Environment (DTA)*
- \* *Agri-food and Biosciences (DISBA)*
- \* *Biomedical Sciences (DSB)*
- \* *Engineering, ICT and Technologies for Energy and Transport (DIIET)*
- \* *Humanities, Social Sciences and Cultural Heritage (DSU)*





DSCTM

Department of  
**CHEMICAL SCIENCE and  
MATERIALS TECHNOLOGY**

[www.dsctm.cnr.it](http://www.dsctm.cnr.it)

DSCTM



01

GREEN  
CHEMISTRY



02

CHEMISTRY  
AND ENERGY



03

CHEMISTRY FOR  
LIFE SCIENCES



04

ADVANCED  
MATERIALS



CHEMISTRY FOR  
CULTURAL  
HERITAGE

05



COMPUTATIONAL  
CHEMISTRY

06

# Il Futuro della Plastica



Un mondo senza plastica in 20 anni?



# Packaging e Sostenibilità

## The Challenge



In developing countries **40%** of food losses occur at post-harvest and processing levels. This is partly due to the lack of appropriate packaging solutions.

Source: FAO report "Global food losses and food waste"

## The Innovation



In Europe, **only 3%** of all products delivered to customers are spoilt between production and transport, thanks to packaging. For example egg breakage is reduced by 80% when using plastic egg packs instead of alternative materials

# L'evoluzione del Packaging

Thickness ↓

Shelf life ↑



Short shelf-life



Barrier packaging



High barrier packaging

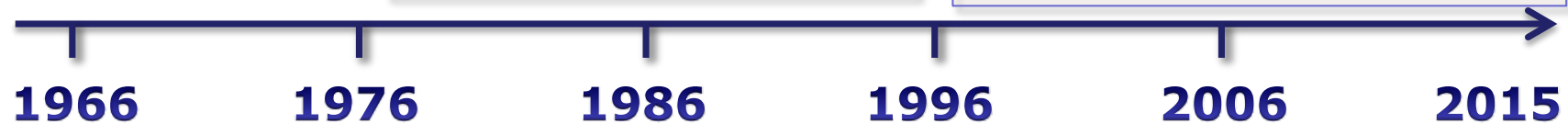
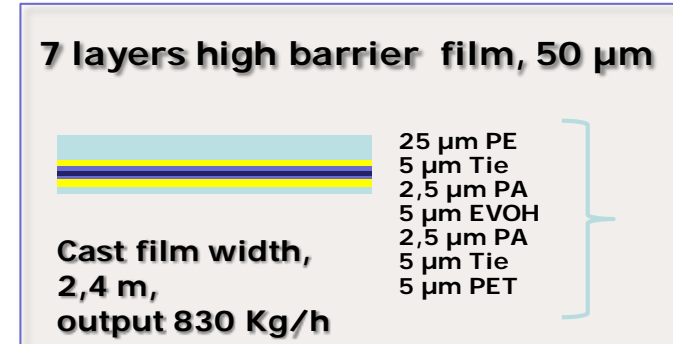
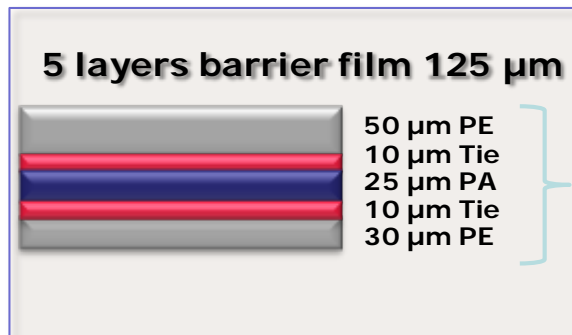



# Nuove tecnologie per il packaging

- La dimensione della produzione e dell'uso di imballaggi rende urgente il problema della **riciclabilità** o della **biodegradabilità** dei materiali da imballaggio



Advances in the Packaging Industry 2017

2<sup>nd</sup> International Congress  
Advances in the  
Packaging Industry  
Product and Process

**Milan (Italy)**  
**October 26-27, 2017**  
Fondazione Cariplo



GIFLEX  
GRUPPO IMBALLAGGIO FLESSIBILE

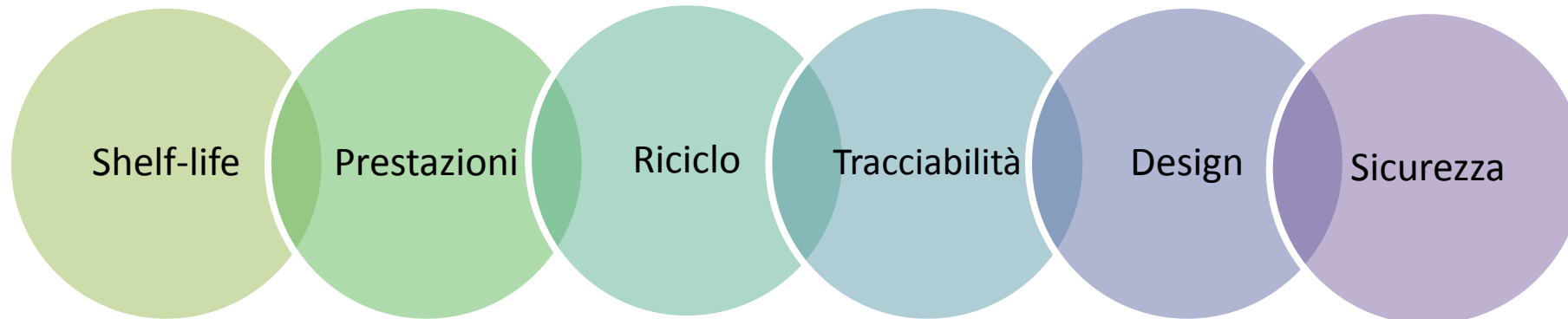

# Towards a Circular Economy



## PRINCIPLE 1

### 1

Preserve and enhance natural capital by controlling finite stocks and balancing renewable resource flows



Regenerate    Substitute materials    Virtualise    Restore

Renewables flow management

Stock management

## PRINCIPLE 2

### 2

Optimise resource yields by circulating products, components and materials in use at the highest utility at all times in both technical and biological cycles

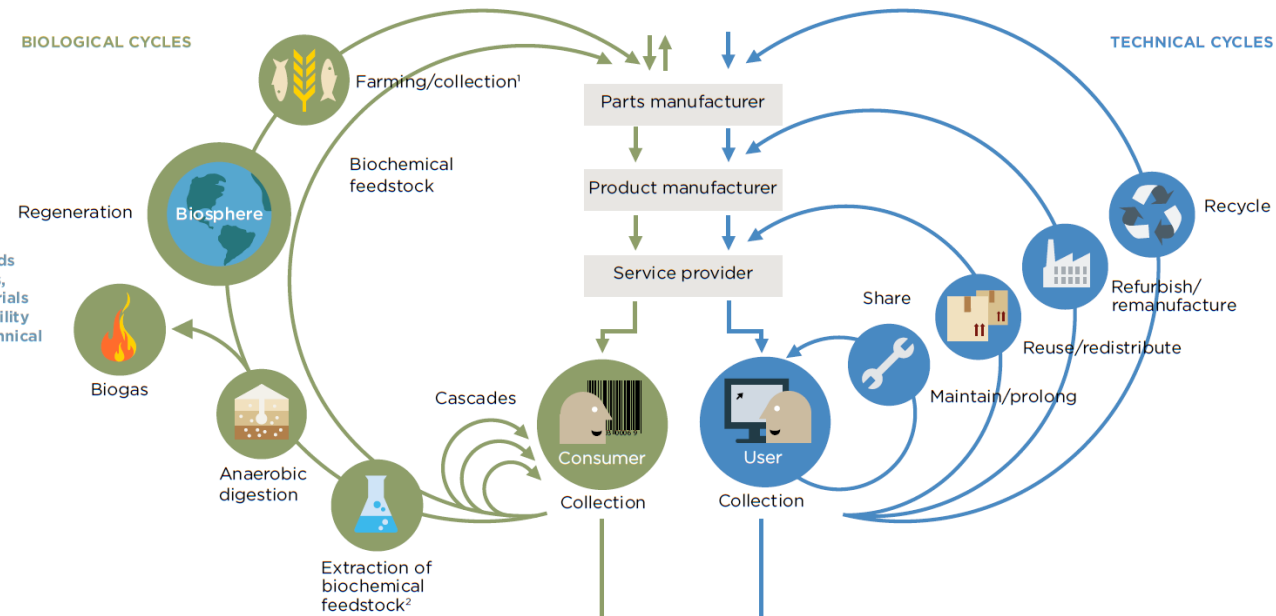

## PRINCIPLE 3

### 3

Foster system effectiveness by revealing and designing out negative externalities

Minimise systematic leakage and negative externalities

1. Hunting and fishing  
2. Can take both post-harvest and post-consumer waste as an input

Source: Ellen MacArthur Foundation and McKinsey Center for Business and Environment; Adapted from Braungart & McDonough, Cradle to Cradle (C2C).

# Economia del riciclo

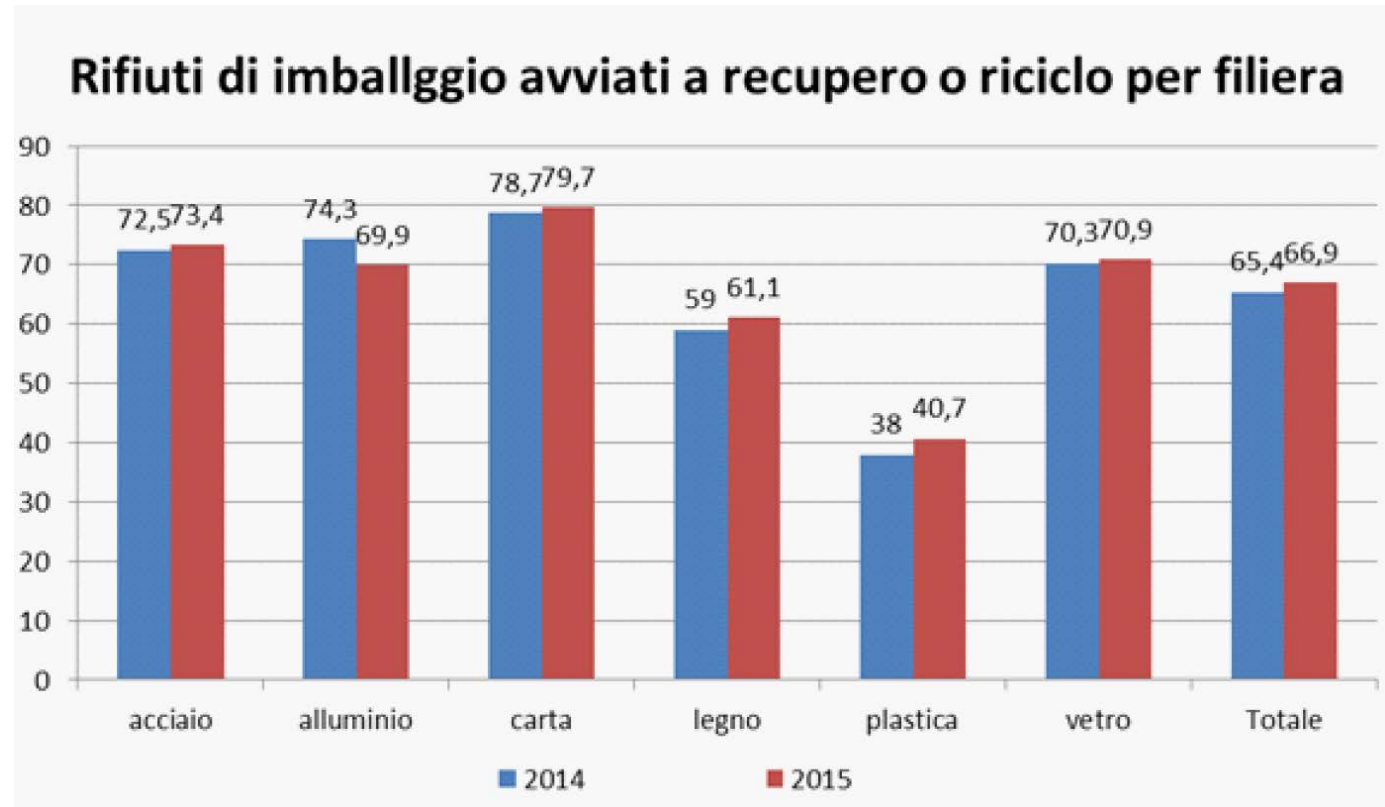

Fonte: Programma generale di Prevenzione e di Gestione degli imballaggi e dei rifiuti di imballaggio CONAI- Relazione generale consuntiva 2015.



# CNR-CONAI Agreement (2014)

**LINE 1: Mechanical recycling of post-consumer multimaterial scraps to get new 100% recycled composite and/or to recover the metallic fraction**



**LINE 2: Valorization of post-consumer polyolefin scraps polluted by other post-consumer plastics through functionalization and/or compatibilization strategies**



# Bioeconomia e Economia Circolare

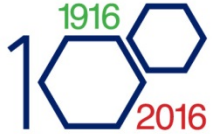

FEDERCHIMICA  
CONFINDUSTRIA

## Industria chimica e Bioeconomia

### L'industria chimica è nel cuore della Bioeconomia

- La sostenibilità, l'uso efficiente delle risorse, il cambiamento climatico e la gestione dei rifiuti stanno diventando questioni sempre più urgenti in Europa, sia per le Istituzioni che per i consumatori. Questi aspetti rappresentano oggi uno dei principali *megatrend* di mercato, e le fonti rinnovabili possono offrire un'opportunità per sviluppare soluzioni performanti e sostenibili, in linea con i principi dell'economia circolare. La chimica da biomasse e il settore delle biotecnologie industriali in Italia sono fortemente impegnati su questi temi e hanno una posizione di eccellenza nel mercato globale.
- Tra i settori che si considerano nella Bioeconomia, **l'Industria Bio-based** e, in particolare, la **Chimica da biomasse** ha un ruolo centrale.



13 marzo 2017

# Lo stadio di sviluppo dei Biopolimeri



**Non tutti i BIOPOLIMERI sono BIODEGRADABILI**

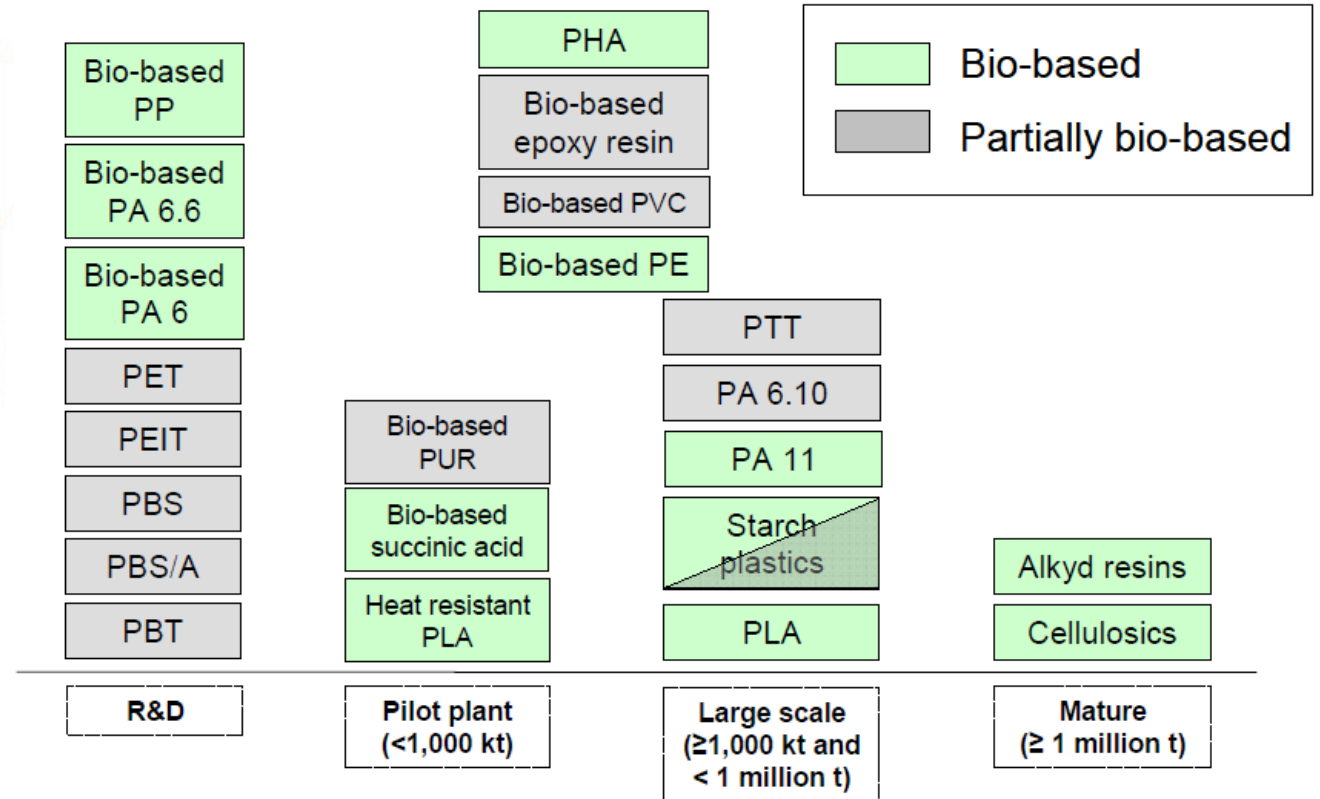





# Un progetto per la bioeconomia e il territorio

[www.biopolis.net](http://www.biopolis.net)



## 7 Istituti di 4 Dipartimenti CNR coinvolti

Dipartimento Scienze Chimiche e Tecnologie dei Materiali (DSCTM)

Dipartimento Agroalimentare e Bioscienze (DISBA)

Dipartimento Ingegneria, ICT e Tecnologie per l'Energia e i Trasporti (DIITET)

Dipartimento Terra e Ambiente (DTA)

Finanziato da



Partner





# Biomassa: aree degradate/marginali



Phragmites australis su suoli salini

## Colture erbacee



Cardo su suoli degradati



Eucaliptus su discarica  
contaminata da Rame

## Colture forestali



Pioppo su area industriale  
contaminata da Piombo



# I processi di trasformazione



Finanziato da





Estrusione-filmatura



Spalmatura adesivo

# Scarti agroalimentari



## Italia:

- Pomodoro (0,13 ton di scarti: buccette, semi)
- Uva (1,5 Mil di ton)
- Paglia (2,2 Mil di ton)
- Lolla (0,3 Mil di ton)
- Pula (0,1 Mil di ton)
- Agrumi
- Cruscame
- Prodotti da forno

## Mondo:

- 200 Mil ton di siero di latte (lattosio)



Materiali  
Additivi per Packaging  
Nutraceutica  
Cosmesi



Biomolecole  
Olii, flavonoidi,  
polifenoli, pectine...

Biomassa  
Cellulosa, Lignina,  
Proteine



# Le proteine da scarti di cereali

Pearl Millet  
Maize  
Sorghum



Pennisetin  
Zein  
kafirin



Spent grain-Brewer  
Biofuel

Protein  
Extraction

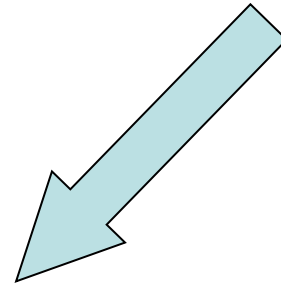
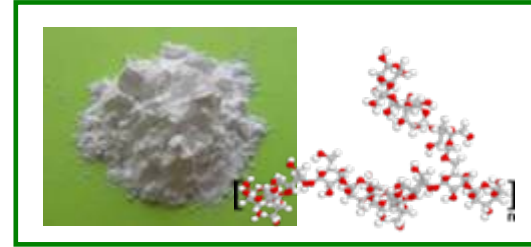

Dry



Wet



Thermoplastic materials

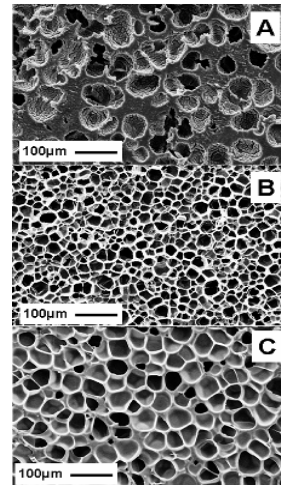

Edible and Bioactive Coatings

## Applications

Migration barrier within foods

- moisture, lipids

Barrier coating on foods

- O<sub>2</sub>, CO<sub>2</sub>, aroma

- moisture

Controlled release carrier

- preservatives, anti-oxidants- aroma, nutrients e.t.c.



# Il design dei prodotti

Produrre solo quello che può RICIRCOLARE

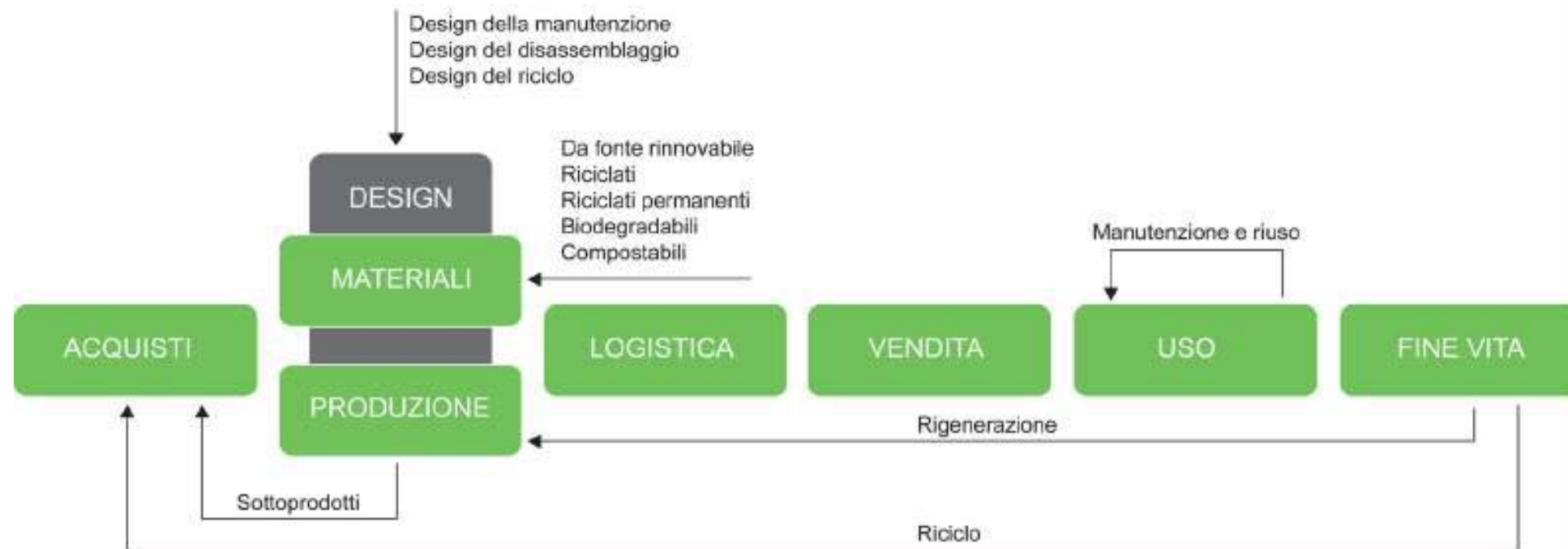

# La complessità dei materiali naturali

lightweight and structural properties

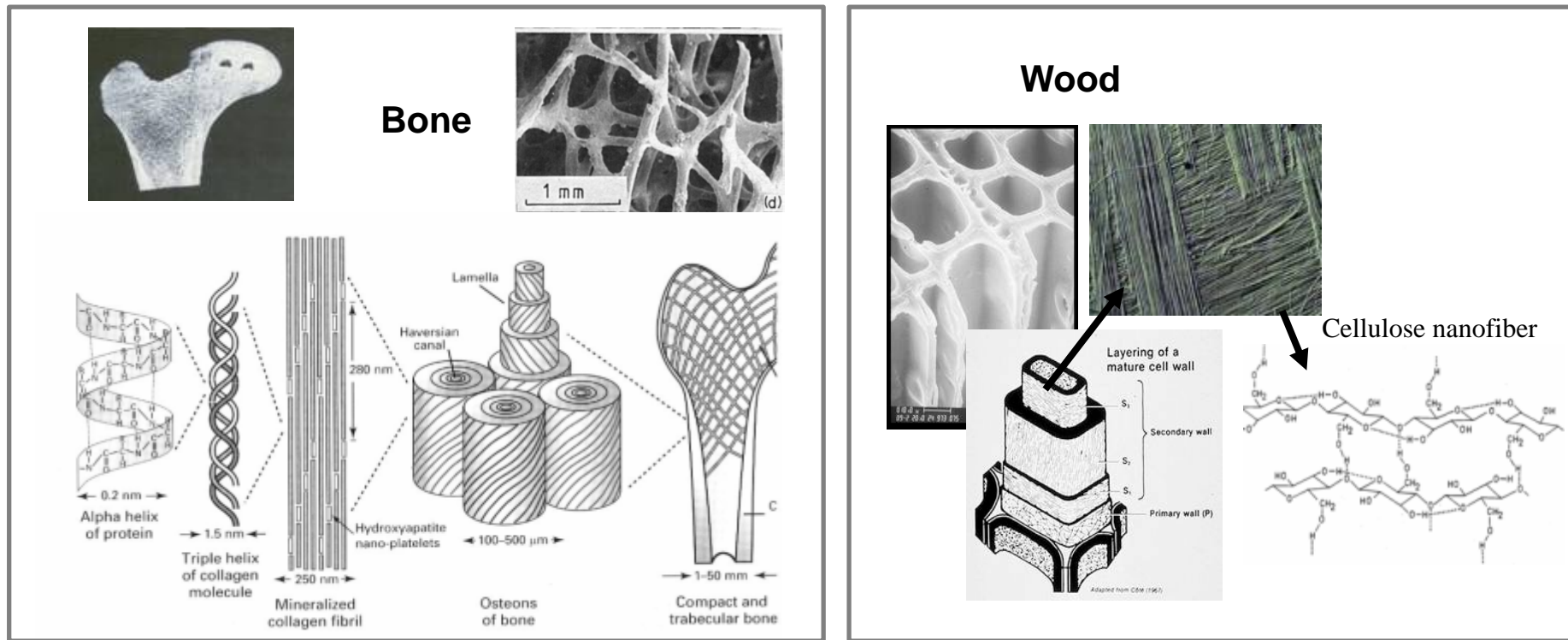

Nature has optimised the composition and structure of the tissues to fulfil the specific function.

- Heterogeneity
- Anisotropy

# I materiali innovativi sono multiscala e multifase

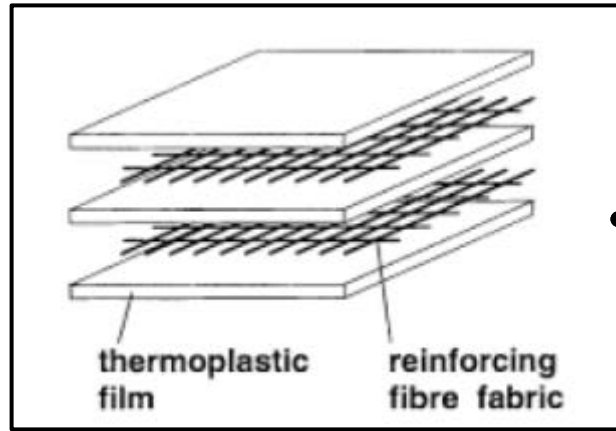

## Compositi avanzati

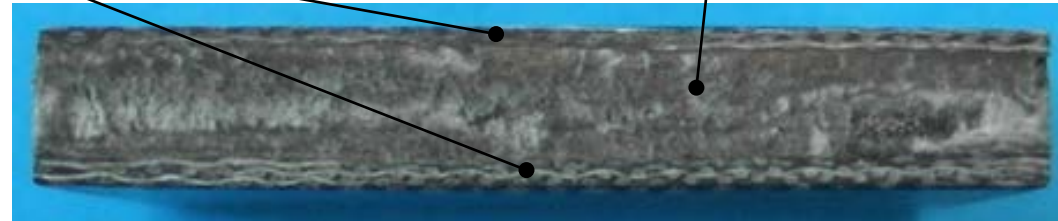
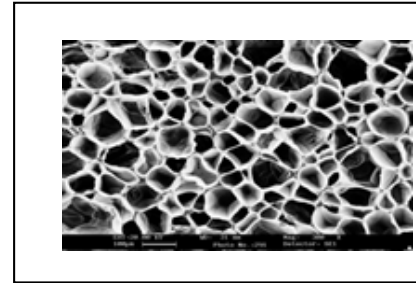

## Materiali per optoelettronica

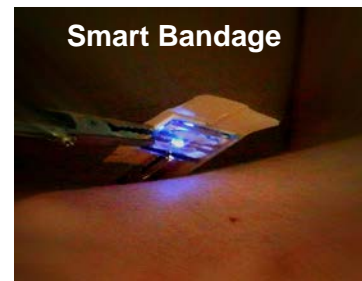
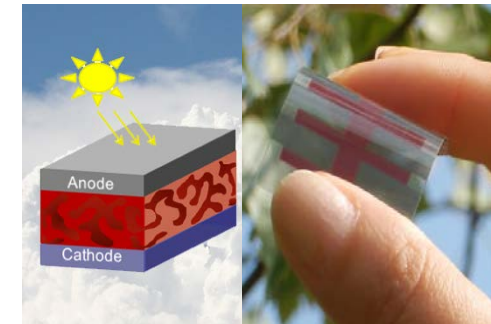
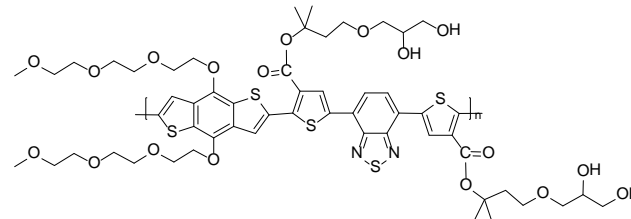
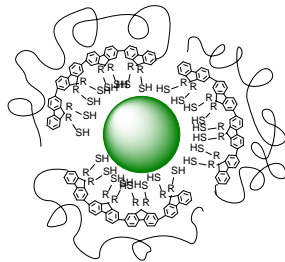
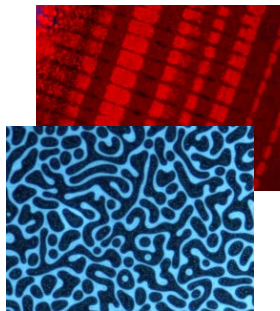

**OLEDs**



**horticulture**

**REPORT FROM THE COMMISSION TO THE EUROPEAN PARLIAMENT, THE  
COUNCIL, THE EUROPEAN ECONOMIC AND SOCIAL COMMITTEE AND THE  
COMMITTEE OF THE REGIONS**

**on the implementation of the Circular Economy Action Plan**

**Research and Innovation: Industry 2020 in the circular economy**

The Horizon 2020 Work Programme 2016-17 invests € 650 million in a Focus Area on "Industry 2020 in the circular economy" which grants funds to demonstrate the economic and environmental feasibility of the circular economy approach, and at the same time give a strong impetus to the re-industrialisation of the EU. In 2016, multiple calls were opened under the focus area, including one dedicated to large-scale projects for systemic, eco-innovative approaches for the circular economy and to water in the circular economy. Evaluation of proposals submitted to these topics took place recently and grant-agreement preparation for the projects selected is ongoing. Additional calls have also been launched in 2016, within the framework of the Public Private Partnerships on "**Factories of the Future**", "**Sustainable Process Industries**" and "**Bio-based Industries**" to help develop and deploy the necessary key enabling technologies to support EU manufacturing across a broad range of sectors.



# Economia basata sulla conoscenza

## Collaborazioni con Imprese

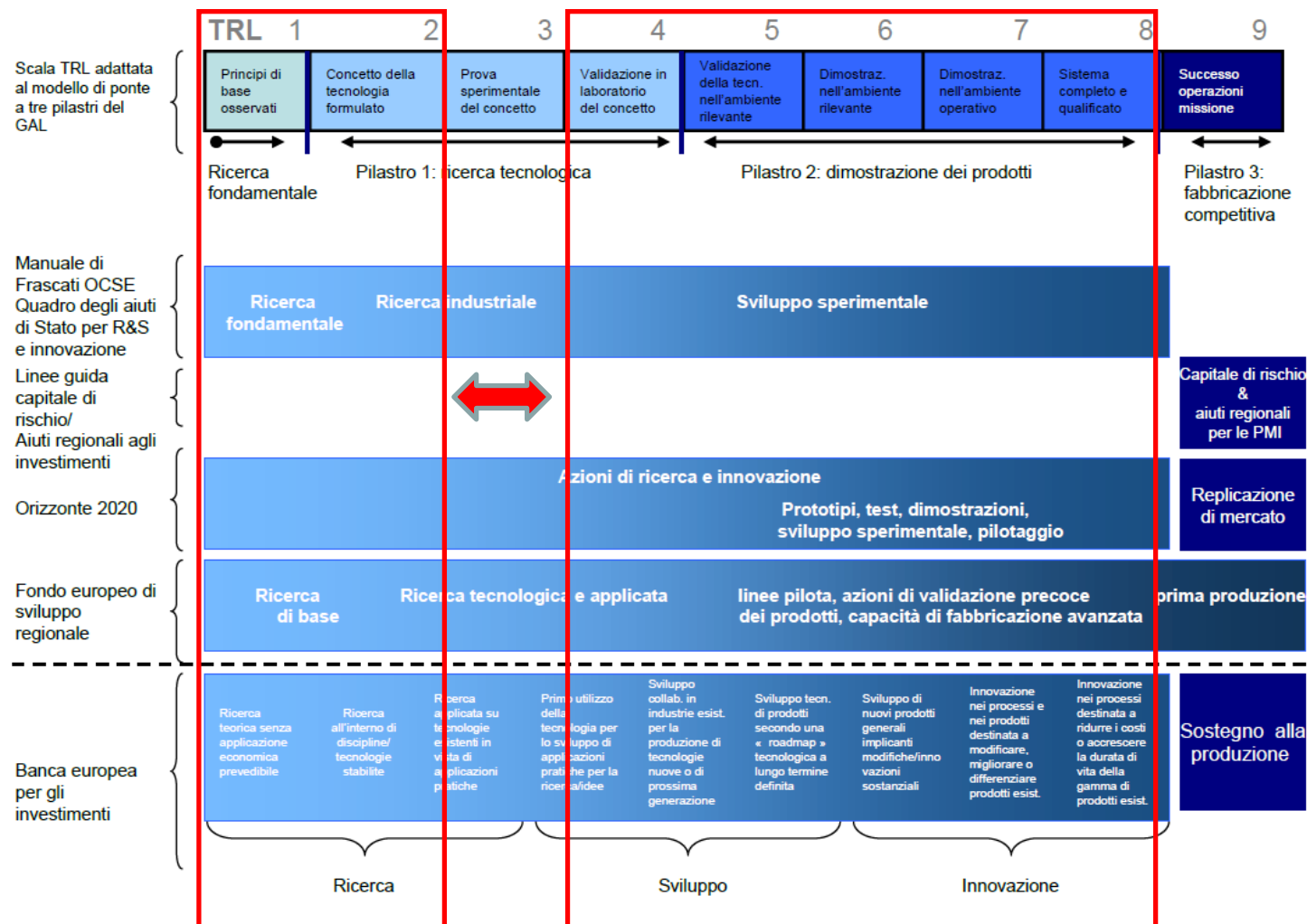

**Incentivare gli investimenti privati nello sviluppo di nuova conoscenza!!**

# GRAZIE

## Alcuni spunti di riflessione

Semplicità vs complessità

Approccio olistico e multidisciplinare

Risorse per lo sviluppo di nuova conoscenza

Salvatore Iannace

Via E. Bassini 15, 20133 Milano

e-mail: [iannace@ismac.cnr.it](mailto:iannace@ismac.cnr.it)



# CNR-ISMAC





# Towards a Circular Economy



Il concetto chiave che sta alla base dell'**economia circolare** è che non c'è un inizio e una fine del processo di produzione economica, con materie prime in entrata e rifiuti in uscita, bensì, come in un ciclo, i prodotti e gli scarti finali di un processo produttivo diventano il punto di partenza di un altro ciclo produttivo.



# La catena di valore della bioeconomia

La **Bioeconomia** si basa sulla **produzione sostenibile di risorse biologiche rinnovabili** e sulla **conversione** di tali risorse e dei flussi di rifiuti/scarti in **prodotti industriali a valore aggiunto**.

La bioeconomia coniuga **sostenibilità ambientale** con le richieste sempre più pressanti che provengono da settori strategici quali: **agricoltura – salute – industria**

La bioeconomia garantisce una “**riconciliazione**” tra **sostenibilità ambientale e crescita economica e sociale** (Strategia Nazionale di Specializzazione Intelligente e Strategia Nazionale italiana per lo Sviluppo Sostenibile).

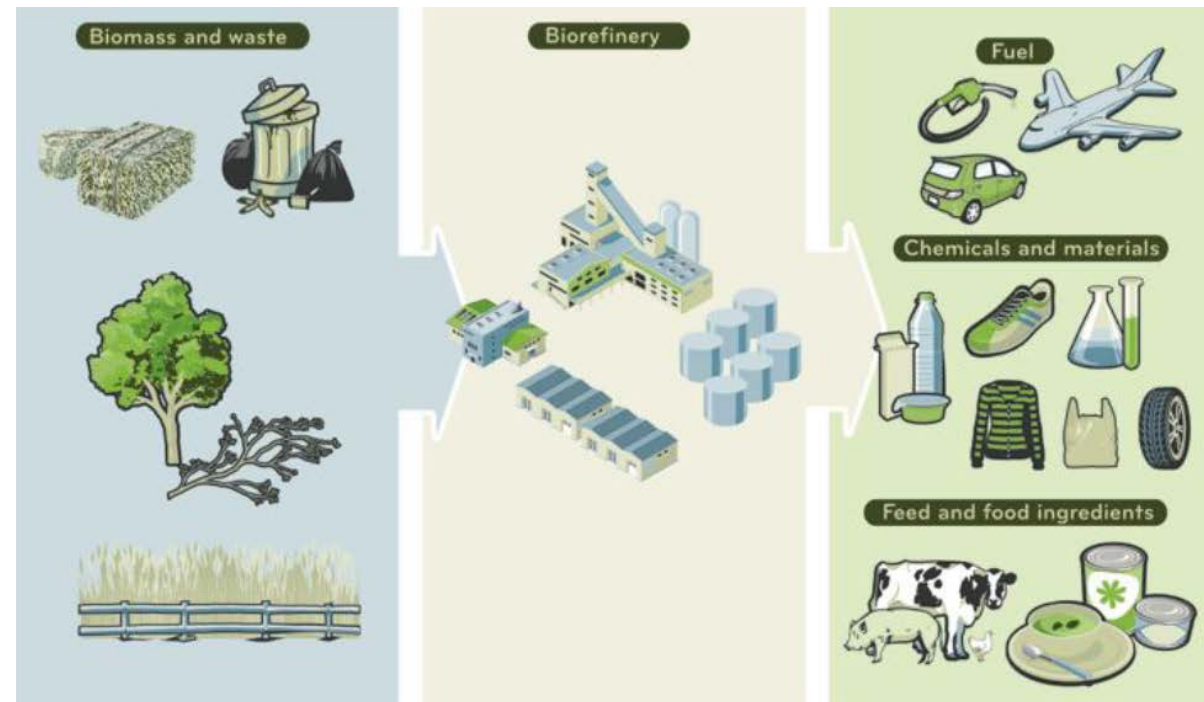
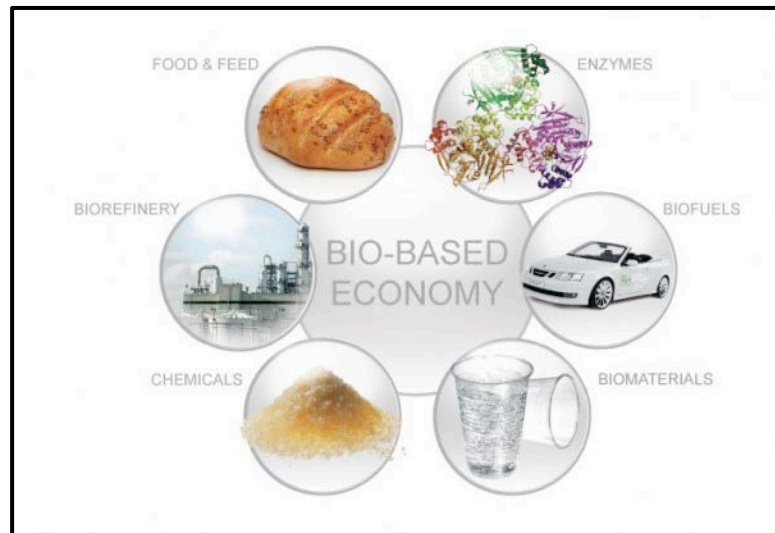

## Parola d'ordine: sostenibilità

È il centro dell'**economia circolare**.  
Un modello che vede il riutilizzo costante delle materie senza prodotti di scarto.

Ma non fa bene solo all'ambiente, il settore occupazionale può trarne dei benefici.

Secondo lo studio Economic Growth Potential of More Circular Economies, **potrebbero nascere tra 1,2 milioni e i tre milioni di posti di lavoro**.



A European Technology Platform for Sustainable Chemistry

## The End of an Era

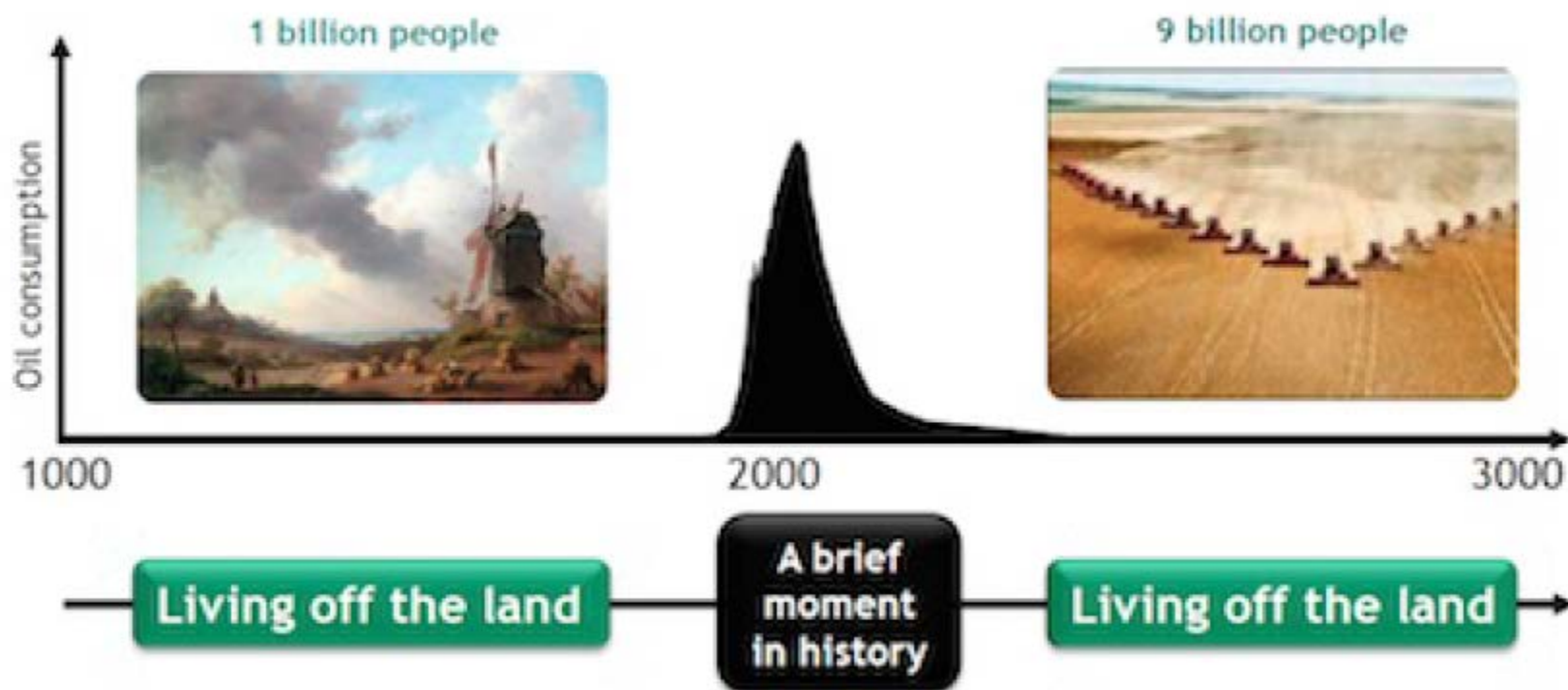

The Oil age will end long before we run out of oil  
And while running out, it will become much more expensive



# Is Italy doing well in Bioeconomy?







... rank third in Europe in terms of pure biotech companies

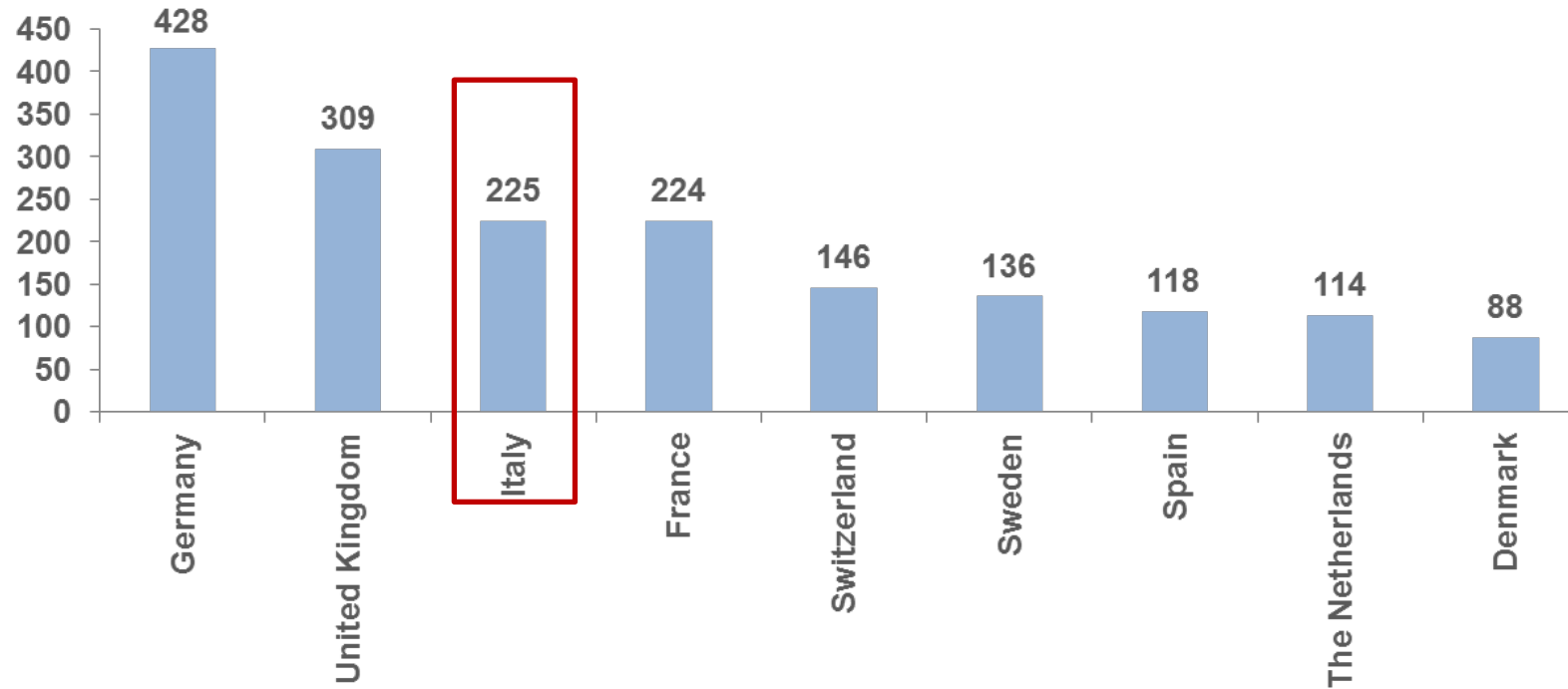

Source: elaboration on E&Y data 2014

## Biotech industry in Italy

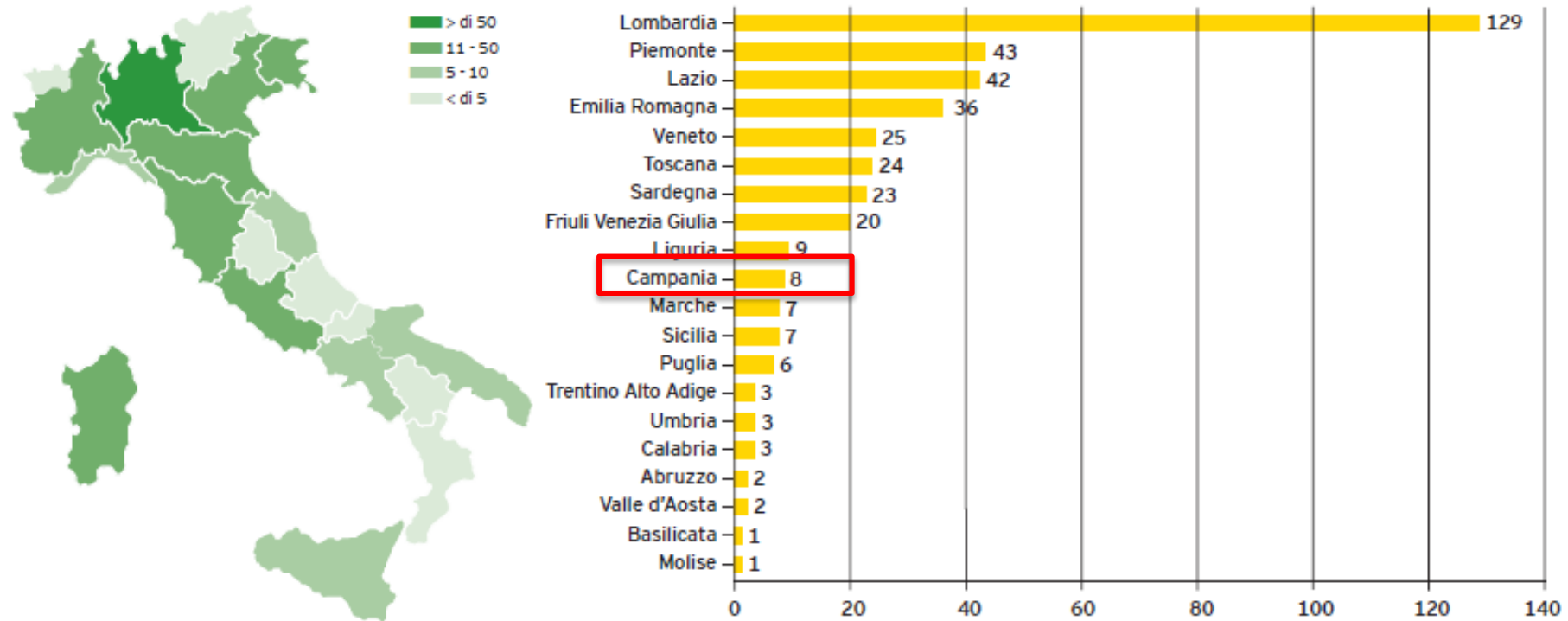

## **CNR Consiglio Nazionale delle Ricerche:**

DIITET	Dipartimento di Ingegneria, ICT e Tecnologie per l'Energia e i Trasporti
DiSBA	Dipartimento di Scienze Bio-Agroalimentari
DSCTM	Dipartimento di Scienze Chimiche e Tecnologie dei Materiali
IBIMET	Istituto di Biometeorologia
ICB	Istituto di Chimica Biomolecolare
ICCOM	Istituto di Chimica dei Composti Organometallici
ICRM	Istituto di Chimica del Riconoscimento Molecolare
IFAC	Istituto di Fisica Applicata "Nello Carrara"
IFC	Istituto di Fisiologia Clinica
IGV	Istituto di Genetica Vegetale
IM	Istituto Motori
INO	Istituto Nazionale di Ottica
IPCF	Istituto per i Processi Chimico Fisici
IRSA	Istituto di Ricerca sulle Acque
ISE	Istituto per lo Studio degli Ecosistemi
ISMAC	Istituto per lo Studio delle Macromolecole
ISTEC	Istituto di Scienze e Tecnologia dei Materiali Ceramici
ISTM	Istituto di Scienze e Tecnologie Molecolari
ITAE	Istituto di Tecnologie Avanzate per l'Energia "Nicola Giordano"
ITB	Istituto di Tecnologie Biomediche
ITC	Istituto per le Tecnologie della Costruzione
ITM	Istituto per la Tecnologia delle Membrane
IVALSA	Istituto per la valorizzazione del legno e delle specie arboree

# Objectives and Motivations



- Nanocomposite and organic-inorganic hybrid foams
  - Improve the properties of the organic matrix
  - Routes towards nano-cellular foams
- Hierarchical porous structures
  - Improve functionalities of the cellular structure
- Innovative concepts for light-weight structures
  - Reduce weight while keeping structural and functional performances



# Imballaggi attivi

## Natural antimicrobials

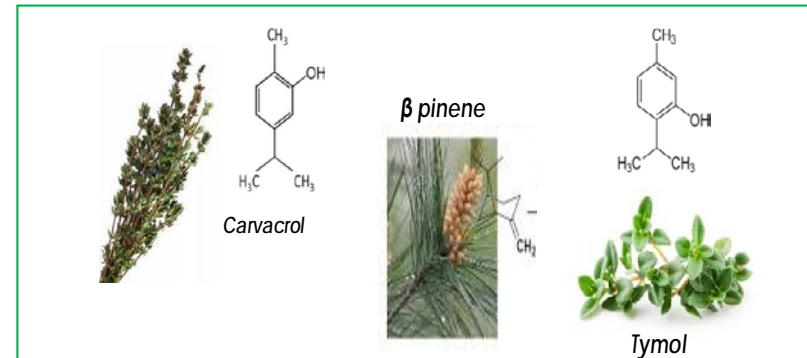

# Biostimolanti e valutazioni agronomiche

Prodotti di semisintesi da estratto igninico idrosolubile via "Click Chemistry" per aumentare la capacità fitostimolanti

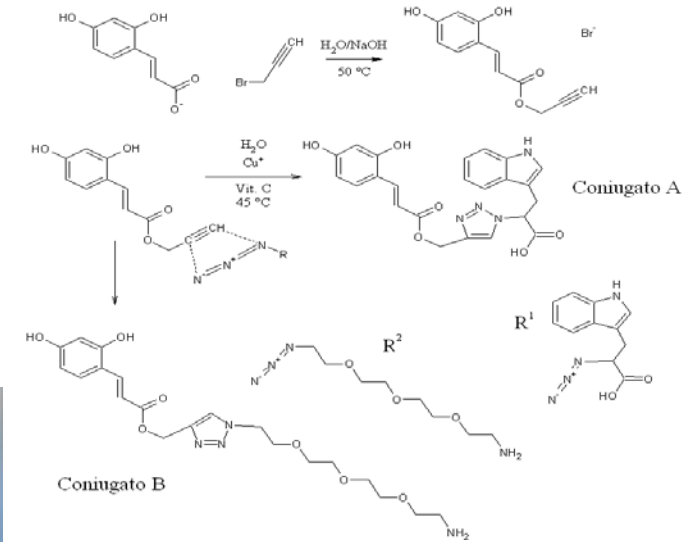
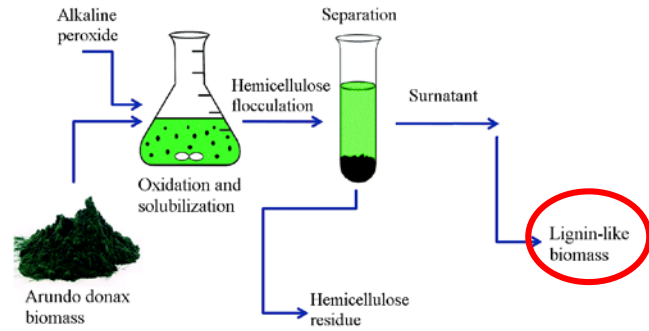

11 maggio 2017

Centro Congressi Federico II

evento conclusivo PON03PE\_00107\_1

Finanziato da



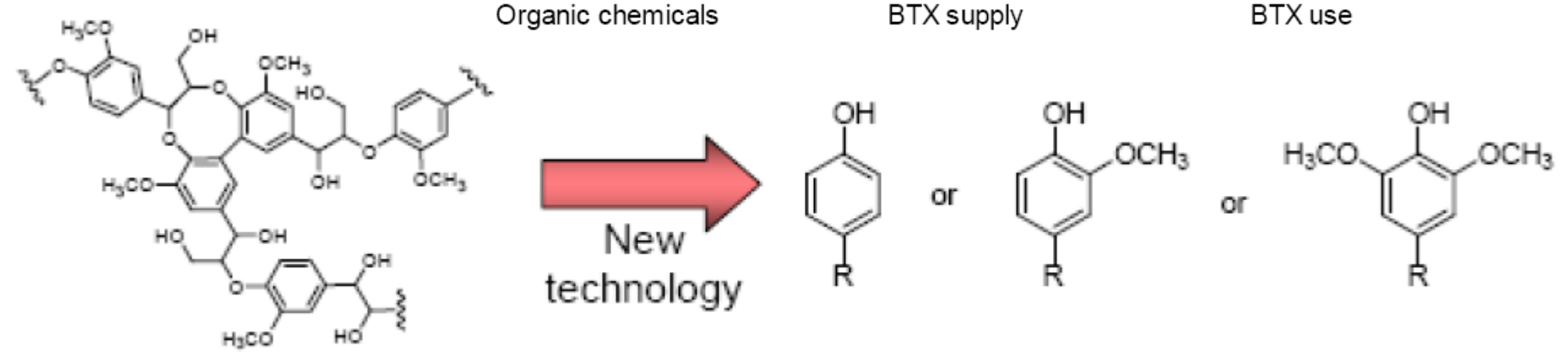
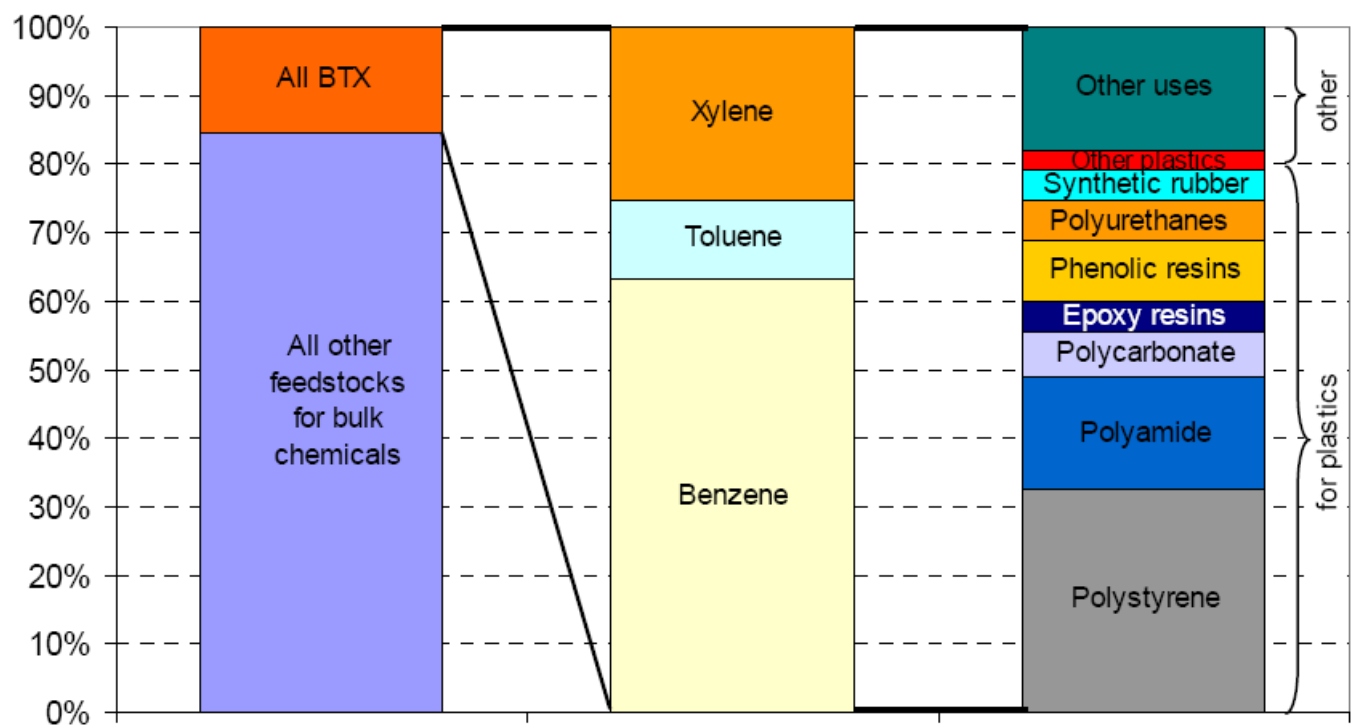

**Lignin**

**or many others aromatic based chemicals**

# La complessità dei materiali avanzati

	Natural Hierarchical Materials	Synthetic Hierarchical Materials
Structure		
Composition	Light elements dominate: C, H, O, N, S, P, Ca, Si and so on	Large variety of elements: C, H, O, N, S, P, Ca, Si, Ti, Zr, Al, Fe, Co, Ni, Cu, Zn, Y, Nb and so on.
Process	Controlled self-assembly	Templating synthesis or spontaneous synthesis
Structure	Very precise and complex	Relatively simple
Length	Molecule, nano-, microlevels	Molecule, nano-, microlevels
Morphology	Self-changing according to the change of environment	Controlled size and shape
<b>Functional Properties</b>		
Functions	Specific functionality	Multiple functionalities design
Lifetime	Self-healing or self-repairing	Few examples of self-repairing
Stability	Very narrow temperature range and pH values range	Thermal and chemical stability
Influence of environment	Natural conditions (suited temperature, moisture, pressure, etc.)	Wide condition range