



INTERNATIONAL UNION
OF RAILWAYS



R&D ROADMAP DEVELOPMENT

FOR THE BETTER LIFE CYCLE ENVIRONMENTAL PERFORMANCE OF RAILWAY SYSTEM

December 2016

Report: “R&D roadmap development for the better life cycle environmental performance of railway system”

Coordination: Dr Cheul Lee, Korea Rail Research Institute (KRRRI/UIC) and Nicholas Craven, Manager of Unit - Sustainable Development (UIC)

Technical support: Sustainable Development Foundation (Team: Raimondo Orsini, Massimo Ciuffini, Luca Refrigeri, Massimiliano Bienati, Valeria Gentili)

Table of contents

Table of contents.....	3
Introduction.....	5
1 European Requirements (Legislation summary)	6
1.1 Energy and Carbon	6
1.1.1 Climate and Energy Package, 2009.....	6
1.1.2 Transport White Paper, 2011	6
1.1.3 Climate and Energy policy framework, 2014.....	7
1.1.4 Communication on transport decarbonisation, 2016	7
1.2 Noise	7
1.2.1 Summary.....	7
1.2.2 Background.....	7
1.3 Air	8
1.4 Materials and Recyclability.....	9
1.4.1 Vehicle recycling	9
1.4.2 Electrical & Electronic Equipment	10
1.4.3 Chemicals.....	10
1.5 Land Use	11
1.5.1 Pesticides and herbicides	11
1.5.2 Land Take.....	11
2 Future Railway and Environment	13
2.1 ERRAC	13
2.1.1 ERRAC organization	13
2.1.2 ERRAC Road map	15
2.2 EES strategy	16
2.3 Other technical strategies	17
2.3.1 Shift2Rail.....	17
3 Key Environmental Requirements of Railway	25
3.1 Energy Efficiency.....	25
3.1.1 Current situation.....	25
3.1.2 Challenges and limitations.....	33
3.1.3 Recommendation	40
3.2 CO ₂ Reduction.....	52
3.2.1 Current situation.....	52

3.2.2	Challenges and limitations.....	57
3.2.3	Recommendation	62
3.3	NOISE	66
3.3.1	Current situation.....	66
3.3.2	Challenges and limitations.....	70
3.3.3	Recommendation	73
3.4	Air Pollution	80
3.4.1	Current situation.....	80
3.4.2	Challenges and limitations.....	82
3.4.3	Recommendation	86
3.5	Recyclability and Materials.....	87
3.5.1	Current situation.....	90
3.5.2	Challenges and limitations.....	95
3.5.3	Recommendation	98
3.6	Land Use	99
3.6.1	Current situation.....	99
3.6.2	Challenges and limitations.....	101
3.6.3	Recommendation	104
3.7	Railway environment management	108
3.7.1	Green procurement: UIC Leaflet 345	108
3.7.2	Uic leaflet 345 and its application and evolution	115
3.7.3	Environmental Report of Railway.....	118
3.7.4	Ecopassenger and Ecotransit.....	123
Conclusions: Energy and Environment R&D roadmap		127
Reference.....		130

Introduction

This report aims to offer Korean Railways an analysis of the European railway industry in the field of environmental sustainability.

This study investigates this topic, describing the activity on these issues of UIC and its members, particularly the major European rail companies. It is a specific point of view that allows the reader to understand what some of the most important actors of this sector – which is very structured and complex – are doing in sustainability.

In Europe, addressing the topic of railways implies the necessity of adopting several different points of view: railway undertakings, infrastructure operators, public administration sectors that deal directly or indirectly with railways by determining investments, setting up public procurement procedures, planning transport services etc.

This is to say that many of the key issues studied in this report can be addressed through different perspectives. Each point of view influences the investigation, which complicates the task of producing an analysis that is complete and concise at the same time.

The report contains three different sections.

The first section discusses the European regulatory framework with respect to the various issues addressed in the report. The European railway sector is strongly influenced by European economic, social and environmental policies. European policies have a key role in determining, and improving the state of the European environment. Today, many environmental policy interventions combine:

- traditional regulatory approaches, sometimes labelled 'command-and-control measures' (for example emission standards, bans of toxic substances, and land planning instruments);
- market-based instruments (such as environmental taxes and greenhouse gas emission trading);
- awareness raising (including for example energy efficiency labels and communication campaigns).

The latest EU environment action program, the 7th EAP, provides an integrated framework for these policy interventions, setting out the long-term ambition of living well, within the limits of our planet.

The railway sector is affected by European policies from many angles.

In some cases, European policies have the goal of promoting rail transport for the beneficial environmental effects brought by the increased use of rail compared to other less sustainable modes. Other policies tend to regulate the different components of the rail sector (railway companies, infrastructure managers, manufacturing industries, etc.) because of their own pressure on the environment and to reduce the negative effects on human health and ecosystems.

The first part of this report studies mostly the European regulatory framework for the reduction of certain negative impacts caused by railways and, more generally, by the transport sector.

The second part of the report addresses the main strategies that railways have developed so that in the future they can increasingly reduce their ecological footprint. Consequently, the second part focuses on what are the strategies, action plans, targets and measures that railways have imagined to improve their environmental performance. Some of these commitments are voluntary, as they emanate directly from the railway companies, such as the EES strategy; others are strategies developed by the railway sector in broader terms, involving different actors dealing with environmental research and innovation such as the ERRAC program or the European research project Shift2Rail.

The third part of the report studies instead what European railways have done, are doing and intend to do for each of the key issues affecting the relationship between railways and environment. The key issues identified are seven, and for each of them the analysis starts by investigating the state of the art, then outlining the challenges and limitations of railways on this issue and finally summarising the recommendations for each topic in the current situation.

1 European Requirements (Legislation summary)

1.1 Energy and Carbon

1.1.1 Climate and Energy Package, 2009

The EU's **2009 Climate and Energy Package** set a wide-ranging framework for European climate and energy policy, with the clear aim of cutting both energy use and greenhouse gas emissions. It set three headline targets to be achieved within the EU by 2020:

- a 20% reduction in greenhouse gas (GHG) emissions below the 1990 level
- a 20% share for renewable energy sources in the energy used
- a 20% saving in primary energy consumption (compared to projections before the agreement on the climate and energy targets for 2020).

The most significant tool used to reduce GHG emissions, and which was updated as part of the 2009 package, is the **EU Emissions Trading System (ETS)**. Transport, with the exception of aviation from 2012, is formally excluded from this. The rail sector is unique within transport, as it is the only mode already effectively included within the ETS due to it being a heavy user of electricity (electricity generation is part included within the ETS).

Another key part of the 2009 package is the "**effort sharing**" proposal. This set binding national targets for each EU Member State to reduce greenhouse gas emissions from non-ETS sources (e.g. transport, buildings, services, and agriculture), between 2005 and 2020. The decision aimed for these emissions to be cut overall to 10% below 2005 levels by 2020. Rather than apply a flat -10% reduction target across all Member States, individual targets based on GDP per capita were set, ranging from -20% (Denmark, Ireland, Luxembourg) to +20% (Bulgaria). The apportioning of the degree of reduction between the different sectors was left to individual governments to decide on.

Finally, the 2009 package included the **Renewables Directive**, which sought to ensure that by 2020, renewable energy comprises at least 20% of the EU's total energy consumption. As part of this agreement, each Member State had to ensure that the share of energy from renewable sources in all forms of transport in 2020 is at least 10% of final consumption of transport energy in that Member State. Originally, it had been expected that this target would be met largely through the use of biofuels. However, amid increasing controversy over the environmental impact of biofuels, the scope of this was expanded to cover the use of renewable energy in all transport modes, including rail.

1.1.2 Transport White Paper, 2011

The 2009 Climate and Energy Package only set goals up to 2020, and there was a widespread agreement that longer-term timescales needed to be considered, along with greater detail on the reductions expected from each sector. The February 2011 European Council agreed to an EU-wide reduction in greenhouse gas emissions by 80-95% in 2050 compared to 1990. Details on how this would be achieved, along with targets for energy use in transport were outlined in the 2011 document, '**Roadmap for moving to a low-carbon economy in 2050**'. The roadmap set goals for 2030 and 2050 and outlined "cost-efficient pathways" for key sectors, including transport. In parallel, the **2011 Transport White Paper** focussed on transforming the transport sector to support mobility and increase transport competitiveness. This set down goals of reducing transport greenhouse gas emissions by 60% by 2050 compared to 1990 and by about 20% by 2030 compared to emissions in 2008. The white paper declared that, "transport has to use less and cleaner energy, better exploit a modern infrastructure and reduce its negative impact on the environment and key natural assets like water, land and ecosystems."

1.1.3 Climate and Energy policy framework, 2014

In 2014 the Commission adopted the **2030 Climate and Energy policy framework**, which consisted of the Communication "A policy framework for climate and energy in the period from 2020 to 2030", and the Communication "Energy Efficiency and its contribution to energy security and the 2030 Framework for climate and energy policy". Transport greenhouse gas emissions covered by the 2030 Climate and Energy package fall into two categories: 1) CO₂ emissions covered by the Emission Trading System (aviation and electricity used by rail) 2) the non-ETS sectors (road, diesel rail, inland waterway). The non-ETS sector is required to reduce its emissions by 30% compared to 2005.

Building on the 2030 **Climate and Energy policy** framework, in October 2014 the European Council agreed, for 2030, to reduce greenhouse gas emissions by at least 40% overall domestically, as well as setting EU-wide renewable energy and energy efficiency targets. Subsequently, the **Energy Union Package** stated that the EU needs to speed up energy efficiency and decarbonisation in the transport sector, the switch to alternative fuels, and the integration of the energy and transport systems.

1.1.4 Communication on transport decarbonisation, 2016

The European Commission is planning to release a Communication on transport decarbonisation during summer 2016, setting further details regarding reducing greenhouse gas (GHG) emissions from transport operations in the EU. The supporting Roadmap for it, published in April 2016 suggests that a key objective will be to present the planned EU level actions and their contribution to transport decarbonisation in 2030, so as to give Member States and other stakeholders an idea of the scale of additional transport actions needed. The rail sector has been calling for the 60% reduction target for transport emissions by 2050, originally laid down in 2011, to be confirmed in legislation, and with an additional binding target for 2030.

1.2 Noise

1.2.1 Summary

The issue of rail noise concerns both the passenger and freight rail sectors, but it is much acute for freight wagons. A number of initiatives have been adopted at the EU level in order to reduce noise exposure and to set common standards. In order to effectively reduce rail freight noise and at the same time keep the railway sector competitive, the European Commission has now adopted a policy mix that combines legislation with other measures, including:

- the harmonisation of noise-charging principles;
- a recommendation on financial support to help the sector make the fleet more silent;
- development of noise-related standards of railway infrastructure;
- the gradual applicability of noise limits set by the EU technical specification for interoperability (TSI) to freight wagons that carry out international transport operations, followed by an obligation for all freight wagons circulating in the EU to be compliant with the same noise limits.

1.2.2 Background

The **2002 Environmental Noise Directive (END)** specifies that Member States must calculate noise exposure levels and publish corresponding noise maps (also called 'strategic noise maps'), ensure that information on noise exposure is publically accessible, and adopt action plans to prevent or reduce noise exposure where necessary.

Railway rolling stock has been required to meet certain noise emission limits since 2006. This obligation, applicable only to newly built freight wagons, was introduced under the Railway Interoperability Directive through the **technical specification for interoperability (TSI) on noise**. This was adopted by the Commission in 2005 and amended several times thereafter.

As freight wagons have a long lifespan, the renewal rate of the fleet is slow (2-3 % per year), so it will take at least until 2030 to renew the entire EU fleet. In order to speed-up progress, in 2008 the Commission

adopted a **Communication on rail noise abatement measures** addressing the existing fleet, as part of the 'greening transport' package. It announced a legal proposal to introduce noise-differentiated track access charges (NDTAC) as an economic incentive for retrofitting freight wagons with composite brake blocks. The replacement of cast iron brake blocks with composite brake blocks was deemed to be the most efficient way of significantly reducing the noise generated by freight wagons. Using these blocks can reduce noise levels by up to 10 dB, which means halving them in terms of human perception.

In **Directive 2012/34/EU (the Recast of the first railway package)**, a provision on the possible use of track access charges to account for environmental externalities was enhanced in order to develop an economic incentive to tackle rail freight noise. This type of measure is commonly referred to as Noise-Differentiated Track Access Charges (NDTAC). One of the main purposes of NDTAC should be to provide incentives for fast retrofitting through mandatory bonuses, although the introduction of NDTAC is voluntary for each Member State.

The relevant **Commission Implementing Regulation (EU) 2015/429** setting out the modalities to be followed for the introduction of NDTAC was adopted in March 2015. It harmonises the charging principles across the EU and thus encourages more Member States to introduce noise charging, which would provide more incentives for the sector to retrofit. Currently, NDTAC systems have been established in Germany, the Netherlands and Switzerland. Other countries such as Belgium, Italy and the Czech Republic are also examining NDTAC systems to consider their introduction in the future.

However, the costs linked with retrofitting have been hampering railway undertakings and wagon owners from achieving a faster pace of progress. To assist the sector in meeting these high costs and maintain the competitiveness of the rail sector, the Commission has proposed to co-fund a part of these costs at EU level. This approach was formalised in **Regulation (EU) No 1316/2013** establishing the Connecting Europe Facility (CEF). The European Commission has established the CEF in order to channel substantial investments into infrastructure and thus contribute to closing gaps in European transport, energy and digital networks. One of the specific objectives of the CEF is to support actions to reduce the level of rail freight noise by co-funding the retrofitting of rolling stock. This is in line with the **Commission Decision C (2011) 658**, which aims to reduce obstacles to the internal market and interoperability and prevent overutilization of old-rolling stock. A total budget of €250 million is earmarked under the current financing period until 2020 for rail projects on existing freight wagons, namely the retrofitting using composite brake blocks. The CEF rules state the maximum level of funding would be 20% of the eligible costs, which are the direct costs associated with composite brake blocks and their retrofitting costs. The EU assistance is distributed through calls, running from 2014 until 2020; the first 'noise' call took place in 2014, and the next one will be launched in 2016/2017.

In December 2015 a **Commission Staff Working Document (SWD) on rail freight noise reduction** reviewed existing measures and analysed additional possible solutions that might be considered in the years to come. According to the Commission's calculations only 3% of the European wagon fleet is estimated to be noisy by 2026 if the policy package proposed in the SWD is applied.

1.3 Air

Air pollution has been one of Europe's main political concerns since the late 1970s. European Union policy on air quality has aimed to develop and implement appropriate instruments to improve air quality. The control of emissions from diesel rail vehicles, and promoting and integrating environmental protection requirements into the transport sector are part of these aims. Diesel engines contribute to air pollution by emitting carbon oxide (CO), hydrocarbons (HC), nitrogen oxides (NOx), and particulate matter.

Diesel-powered railway locomotives and railcars have been regulated at an EU level through legislation relating to Non-Road Mobile Machinery (NRMM). Emissions from NRMM engines are regulated before they are placed on the market by **seven NRMM directives**: the 'mother' Directive 97/68/EC, followed by the amendments Directive 2002/88/EC, Directive 2004/26/EC, Directive 2006/105/EC, Directive 2010/26/EU, Directive 2011/88/EU, and the last amendment Directive 2012/46/EU. The original Directive did not cover rail locomotives and railcars until it was amended by Directive 2004/26/EC. Since 2004, manufacturers

must ensure that new engines comply with the limits set out in the Directive before placing their products on the market.

The Directive has introduced emission limits in increasingly stringent phases for rail vehicles. Upon being brought within the scope of the Directive in 2004, locomotives were made subject to 'Stage IIIA' emission limits. 'Stage IIIB' emission limits came into force on 1 January 2012 in place of Stage IIIA. The rail industry expressed concern that the Stage IIIB requirements due to come into force in 2012 were too much of a step up from Stage IIIA and presented technical difficulties which could not be solved in the time frame available. The rail industry and those governments whose rail sectors are heavily reliant on diesel traction lobbied hard for the inclusion of flexibility requirements so as to extend the period in which Stage IIIA compliant locomotives could continue to be marketed. The EU Commission eventually agreed and a flexibility scheme was inserted into the NRMM Directive under Annex XIII. This enabled a limited number of new locomotives to be placed on the market for a period of 3 years after the Stage IIIB requirements came into force; this period expired on 31 December 2014.

The technical constraints of retrofitting IIIB-compliant engines in existing rail vehicles has also been recognised. The requirements for new engines doesn't apply to existing locomotives or railcars that are refurbished. The sector warned that forcing railways to replace the original engine type with a new one could produce a reverse modal shift from rail to road on several lines, which would contradict the objectives of the NRMM Directive and the vision of the 2011 Transport White Paper. As a consequence, Member States have been allowed to authorise the replacement of engines in existing (pre-2012) vehicles with Stage IIIA-compliant engines, by means of a derogation where there is the existence of "significant technical difficulties" in fitting IIIB engines.

The Commission responded to the general concerns of the rail industry on this issue by engaging the industry in a research programme as part of a technology forcing scheme. This is known as the CleanER-D programme and is partly funded by the EU Commission under the 7th Environmental Action Programme.

In September 2014, the European Commission proposed a new regulation covering non-road mobile machinery. The '**Proposal for a Regulation on requirements relating to emission limits and type-approval for internal combustion engines for non-road mobile machinery**' will cut the complexity of the legal framework by repealing the current directive and its amendments, and replace it by a regulation that will have immediate legal effect. The proposal is still under consideration by the European Council and European Parliament.

1.4 Materials and Recyclability

1.4.1 Vehicle recycling

Directive 2000/53/EC on end-of life vehicles (ELV) was introduced to make the dismantling and recycling of end-of-life automotive vehicles more environmentally-friendly. However, the recycling of rail vehicles has not been specified by this or other legislation at the EU level. Hence, there are no legal regulations related to the recycling or recovery rates or the obligations of manufacturers, owners or other entities concerning the disposal of rolling stock.

Instead, the European rail sector continues to rely on advice from UIC. In 2006, UIC developed Leaflet 345 'Environmental specifications for new rolling stock'. According to the recommendations, vehicle designers should incorporate such aspects as material recycling, effective resources management, avoidance of waste generation and the highest possible recovery rate.

Unified recycling guidelines for the rolling stock were also developed in 2008 by Association of the European Rail Industry (UNIFE) with the adaption for rolling stock of the ISO22628 standard for the automotive sector. Other applicable standards were also applied such as ISO14040 and ISO14044, both related to the life cycle assessment. However, none of the standards imposes methods of disposal of the end-of-life rolling stock, leaving the entities a choice between the energy recovery, part reuse and material recycling.

1.4.2 Electrical & Electronic Equipment

To improve the environmental management of Waste Electrical and Electronic Equipment (WEEE), two pieces of legislation were put in place: the **Waste Electrical and Electronic Equipment (WEEE) Directive** (Directive 2002/96/EC, subsequently amended with an increased scope as 2012/19/EU) and the **Restriction of Hazardous Substances (RoHS) Directive** (2002/95/EC, subsequently revised, also with an increased scope, as recast Directive 2011/65/EU).

The objective of both the WEEE and the RoHS Directives is to lay down measures to protect the environment and human health by preventing or reducing the adverse impacts of waste from electrical and electronic equipment. The improvement of collection, treatment and recycling of electronics at the end of their life was considered necessary, and the directives aim to encourage a circular economy and enhance resource efficiency. However, the rail sector largely falls outside of the scope of both directives. The majority of equipment for the rail industry will continue to not be part of the scope of either directive as it falls into one (or more) of the following exclusions: Means of Transport for Persons and Goods; Large Scale Fixed Installations; Large Scale Stationary Industrial Tools; Non-road mobile machinery for professional use. In particular, items that are specifically designed for rolling stock or rail infrastructure or to be a part of large-scale fixed installations or a large-scale stationary industrial tools, are excluded.

Consequently this means that the relevance of WEEE and RoHS for rolling stock or rail infrastructure is limited to just a few products. Examples of equipment used in rail applications that is considered in the scope of WEEE or RoHS are portable items not specifically designed for rail applications, such as laptop computers and computer screens, handheld equipment such as installation, test and maintenance tools, and kitchen equipment.

Figure 1 Relevance of WEEE for Rail System

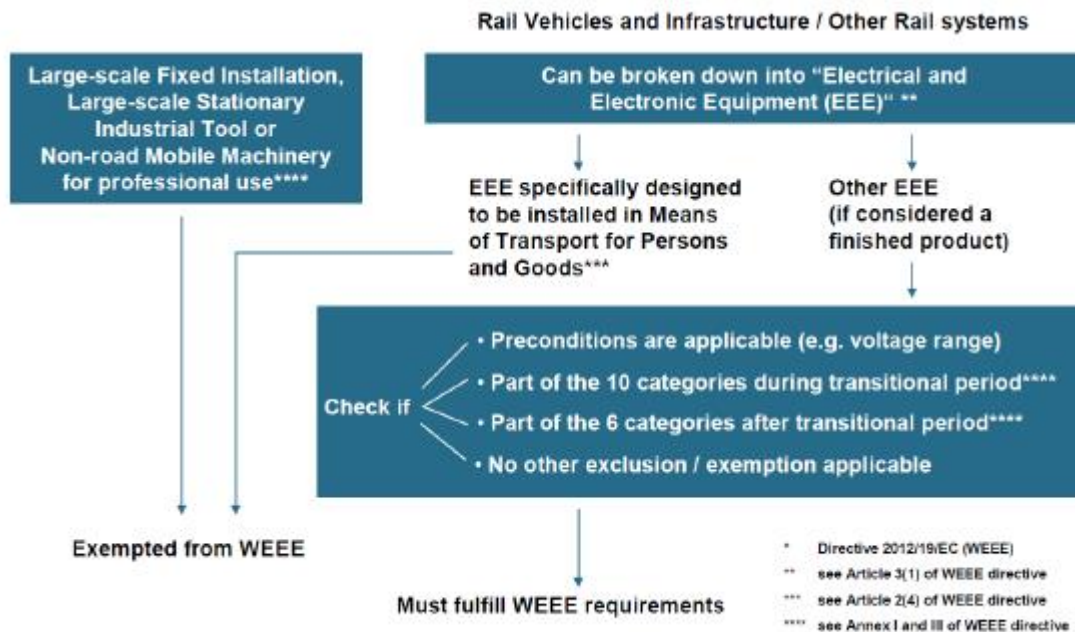

1.4.3 Chemicals

The Registration, Evaluation, Authorisation and Restriction of Chemicals (REACH) Regulation was adopted by the EU in 2006. It addresses the production and use of chemical substances, and their potential impacts on both human health and the environment. REACH came into force in 2007, with a phased implementation taking place until 2018. When REACH is fully in force, it will require all companies manufacturing or importing chemical substances into the European Union in quantities of one tonne or more per year to register these substances with a new European Chemicals Agency. Since REACH applies to

some substances that are contained in objects (described as ‘articles’ in REACH terminology), any company importing goods into Europe can be impacted by REACH.

The regulation impacts the rail sector in various ways. Based on REACH definitions, rail sector members may be affected as:

- Producer of an article: anyone who makes or assembles an article within the EU
- Manufacturer: anyone who manufactures a substance within the EU
- Importer: anyone who is responsible for import to the EU
- Downstream User (DU): anyone (other than the manufacturer or importer) who uses a substance in an industrial or professional activity
- Distributor: anyone who stores and places on the market a substance for third parties

Rail products such as vehicles themselves as well as components for rail vehicles are considered to be ‘articles’. The same obligations to pre-register and register apply for substances that are contained in articles and that will be released under normal or reasonably foreseeable conditions of use. Articles which intentionally release substances include:

- Equipment to lubricate wheel flanges (e.g. wheel flange lubricating grease)
- Equipment to clean windscreens (e.g. cleaning and antifreeze agents)
- Fire extinguishing equipment when installed on trains

Natural substances (such as braking sand) are excluded from the requirement to register.

1.5 Land Use

1.5.1 Pesticides and herbicides

In 2000, the European Union adopted the **Water Framework Directive** (WFD) which introduces a new legislative approach to managing and protecting water, based not on national or political boundaries but on natural geographical and hydrological formations. It also set out a precise timetable for action, with 2015 as the target date for getting all European waters into good condition. (However, by 2015 less than half of all waters met the required standard.)

The WFD led to a series of other directives designed to cut the use of water pollutants. Herbicide use has been restricted by the **Groundwater Directive**, passed in 2006. The **Framework Directive on the Sustainable Use of Pesticides** (2009/128/EC), banned the use of 22 pesticide ingredients. It aims to reduce risks and impacts of the use of pesticides on human health and on the environment, promote the use of integrated pest management and the use of alternative techniques. The accompanying **Sustainable Use Directive** requires EU member states to draw up an action plan to reduce the harm caused by pesticides, and also aims to promote the use of alternative pest management methods. The **Pesticides Authorisation Regulation**, which came into effect in June 2011, tightened controls further.

The European rail sector has said that full prohibition of herbicide usage along any kind of railway infrastructure is not feasible. It has warned that uncontrolled weeds can lead to potential railway traffic safety issues and reduction of life expectancy of rail infrastructure.

1.5.2 Land Take

Rail infrastructure has had direct as well as indirect impacts on land use, including land take, soil sealing and landscape fragmentation. The **2011 ‘Roadmap to a resource-efficient Europe’** states, that “by 2020, EU policies take into account their direct and indirect impact on land use in the EU and globally, and the rate of land take is on track with an aim to achieve no net land take by 2050; soil erosion is reduced and the soil organic matter increased, with remedial work on contaminated sites well under way.” It also states that EU policy in areas including transport should provide the right incentives to achieve the objective of “no net land take by 2050”. This is reinforced in the Roadmap through the **Efficient Mobility Milestone**, according to which by 2020 “the transport sector will deliver greater value with optimal use of resources like... land”.

The European Commission subsequently adopted, in 2013, a **Communication on ‘Green infrastructure – enhancing Europe’s natural capital’**. It highlights the role of green infrastructure in “protecting, conserving and enhancing EU’s natural capital” through the integration of land use and ecosystem concerns into spatial planning.

Environmental Impact Assessments (EIAs) are mandatory for all schemes likely to have a significant effect on the environment, and therefore include projects that are likely to result in land use changes, land take, or degradation. Strategic Environmental Assessments (SEAs) aim to ensure that environmental considerations are taken into account in the preparation of plans and programmes. The **2014 revision of the EIA directive** (2014/52/EU) strengthens provisions regarding the protection of land and soil.

2 Future Railway and Environment

2.1 ERRAC

The European Rail Research Advisory Council (ERRAC) was founded in 2001 and nowadays it includes 45 representatives from each of the major European rail research stakeholders: manufacturers, operators, infrastructure managers, the European Commission, EU Member States, academics and users' groups. ERRAC covers all forms of rail transport: from conventional, high speed and freight applications to urban and regional services. The most important and ambitious goal for ERRAC, since its launch in 2001, was the creation of a single European body with competence and capability to enhance the EU rail sector and make it more competitive, by fostering increased innovation and guiding research efforts at European level.

In its history, ERRAC has produced a number of important and influential documents, such as: the Joint Strategy for European rail Research – Vision 2020, the SRRA – Strategic Rail Research Agenda and its 2007 updated version, Suburban and Regional Railways Landscape in Europe and others. The most recent document published by the platform is RailRoute 2050, the sustainable backbone of the Single European Transport Area, aimed at providing an initial update of the strategic vision of ERRAC, in preparation of Horizon 2020.

ERRAC is focussing on two important objectives:

1. Defining, and implementing steps to achieve a joint European rail research and innovation strategy
2. Enhancing collaborative European rail research and innovation by:
 - Building consensus among stakeholders
 - Improving synergies between EU, national and private rail research
 - Strengthening and re-organising research and development efforts
 - Facilitating effective pooling of human and material resources
 - Launching ambitious co-operative research schemes

In general, ERRAC works to ensure the best alignment of the research programmes with the identified ERRAC research priorities, identifying synergies among various corporate, national and EU research programmes, promoting better co-ordination and nurturing/endorsing new research initiatives. Moreover, ERRAC is asked to evaluate on-going and completed projects, drive training and development of engineers with new skills for the emerging technologies and propose input for the EU Framework Program.

However, the ERRAC's specific tasks are:

- Advise on future rail research needs to the European Commission for Horizon 2020
- Promote ERRAC activities and implementing an efficient communication strategy

2.1.1 ERRAC organization

As a European Technology Platform for rail research and innovation, ERRAC membership is comprised of the following rail stakeholder associations and their members:

1. Community of European Railway and Infrastructure Companies (CER)
2. European Federation of Track works Contractors (EFRTC)
3. European Rail Infrastructure Managers (EIM)
4. European Passengers' Federation (EPF)
5. The European Passenger Train and Traction Operating Lessors' Association (EPTTOLA)
6. European Rail Freight Association (ERFA)
7. European rail Research Network of Excellence (EURNEX)
8. European Freight and logistic leaders forum (F&L)
9. International Union of Railways (UIC)

10. International Union of Wagon Keepers (UIP)
11. International Union for Road-Rail Combined Transport (UIRR)
12. International Association of Public Transport (UITP)
13. Association of the European Rail Industry (UNIFE)

The most important and operational elements constituting the ERRAC's organization and structure are:

Plenary

The Plenary comprises of the ERRAC members plus invited members of Academia and research institutions, Member States and the European Commission. The ERRAC Plenary:

- Ratifies the nomination of the ERRAC Chairmanship
- Approves the Annual Report
- Approves the Annual Plan, the work program for ensuing years
- Proposes research and innovation development activities at European and Member State levels.
- The Plenary shall be chaired by the ERRAC Chair person.

Strategic Board

The Strategic Board is in charge of approving and monitoring the proper implementation of ERRAC strategy.

The Strategic Board is the highest decision-making body initiating the general policy of ERRAC according to its aims and mission. In addition, the Strategic Board will be the Strategic or Advisory (to be resolved) Council of the proposed Shift2Rail initiative.

The Strategic Board main tasks are the following:

- Provides strategic orientation for the future work of ERRAC and rail research and innovation
- Takes decision on issues when it was not possible to reach an agreement within the Steering Committee
- Reviews the future work program as proposed by the Steering Committee and recommend its endorsement by the plenary.
- Approves proposals put forward by the Steering Committee regarding ERRAC recommendations for future EU-funded research innovation programs. The Strategic Board's objectives may be amended once Shift2Rail is authorised to ensure alignment.

Steering Committee

The Steering Committee is the body responsible for the operational management of ERRAC activities. In addition, the Steering Committee oversees the creation, composition and operation of any ERRAC Working Groups and Permanent Advisory Groups established for the effective and collaborative working of ERRAC. It also supervises the activities of the Secretariat and the production of ERRAC documents (resolutions, decisions, communications, reports, dissemination material, etc.).

The Steering Committee activity include:

- Execute the ERRAC Work plan
- Propose developments of the ERRAC Annual Work Program to be submitted to the Strategic Board
- Monitor the relevant/overall rail sector contribution to the Horizon 2020 and other research and innovation programs
- Coordinate the implementation of the ERRAC strategies through different Working Groups, established as necessary, and promoting their activities
- Coordinate the selection of delegates for the different Working Groups to ensure a balanced participation between rail sector specialists and the research and technical community

- Monitor progress and harmonise the Working Group tasks and deliverables
- Supervise and evaluate research results and endorse proposed operational deployment ideas emanating from the working groups
- Liaise with national and European funding and policy making bodies (sector, government, public, etc.) and other relevant bodies and agencies (ERA, etc.)
- Link with any other European and national institutions and the corresponding bodies of the technological platforms of other sectors
- Consider nominations for the ERRAC Chair and recommend to the Strategic Board for approval and subsequent presentation to the Plenary for endorsement

Working Groups

The Steering Committee may decide to set up Working Groups that are able to focus on specific issues or activities. These groups shall be open to all members of ERRAC and experts from the railway community are also able to participate in these meetings.

The chair of such groups shall be appointed by the other members and they shall report on their activities to the Steering Committee to which appropriate strategic decisions shall be directed so as to maintain a consistent approach to discharging the ERRAC strategic objectives.

Figure 2 ERRAC Organization

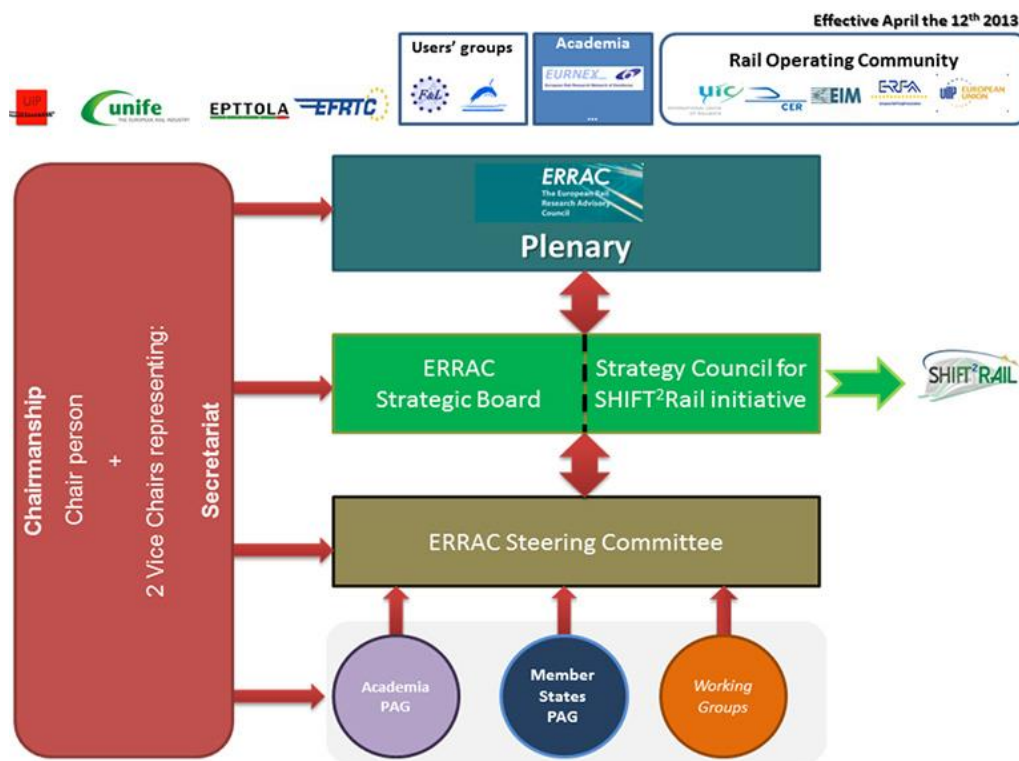

Source: ERRAC Website

2.1.2 ERRAC Road map

The ERRAC Roadmap CSA project was designed to support the Advisory Council in its work and has focused for a period of 3 years on the drafting and delivery of concrete and detailed roadmaps on common European R&D to implement the ERRAC Strategic Rail Research Agenda (SRRA). The ERRAC-ROADMAPS project started on 1 June 2009 and ran for three years and two months. The ERRAC Strategic Rail Research Agenda is based on 6 pillars:

- Energy and Environment
- Personal Security

- Test, Homologation and Safety
- Competitiveness and enabling technologies
- Strategy and Economics
- Infrastructure

A set of 9 Research & Technology Roadmaps were prepared by members of ERRAC and other rail experts, between 2009 and 2012.

Following the set-up of the Transport theme in the European Commission's 7th Framework Programme for Research, the 6 SRRRA priorities were translated towards these 5 areas: Greening of Surface Transport, Encouraging modal shift (long distance) and decongesting transport corridors, sustainable urban transport (including modal shift, light rail vehicles and metros), Safety & Security, Strengthening Competitiveness.

FOSTER-RAIL Project

The European Commission funded FOSTER-RAIL project – which ran from 1 May 2013 until 31 April 2016 – was implemented in order to support the work of the European Rail Research Advisory Council (ERRAC). It addressed the challenge to strengthen and support research and innovation and to enhance the coordination among main stakeholders and actors on the European level as well as between the European and national levels. It integrated the work done so far by ERRAC and its working groups' outcomes, such as the RailRoute 2050 and the Strategic Rail Research Agenda (SRRRA) and other reports. The work carried out in the FOSTER-Rail project allowed to produce the new Strategic Rail Research and Innovation Agenda (SRRRIA) and specific Rail Technology & Innovation Roadmaps aiming at 2050.

2.2 EES strategy

“Moving towards Sustainable Mobility: Rail Sector Strategy 2030 and beyond – Europe –” (generally known as the Sustainable Mobility Strategy) has been developed by the UIC Environment, Energy and Sustainability Core Group and its expert networks in coordination with the UIC Rail System Forum and the CER Transport, Environment & Energy Strategy Group. It builds on the cooperation already undertaken that led to the CER CO₂ commitment in 2008 (which envisages a 30% reduction in specific emissions from rail traction by 2020) by looking at how the rail sector should be performing in environmental terms in the medium (2030) and long (2050) terms. The goal is to adopt a unified Sustainable Mobility Strategy of the rail sector in Europe that is endorsed by the European members of UIC, CER, EIM and UNIFE to strengthen coordination, speed and direction of actions and ensure the widest possible acceptance within the rail industry.

The strategy is primarily aimed at the European rail industry itself: to provide an agreed framework that matches overarching political priorities that all the relevant players in the rail sector can use to guide their work over the next 40 years.

Table 1 UIC-CER Railway sector targets overview at European level

	TARGET	BASELINE	HORIZON
1. CLIMATE PROTECTION	-40% specific CO ₂ emissions (per pkm and tkm)	1990	2020
	-50% specific CO ₂ emissions (per pkm and tkm)	1990	2030
	-30% total CO ₂ emissions	1990	2050
	Carbon-free train operations	-	2050
2. ENERGY EFFICIENCY	-30% specific energy consumption (per pkm and tkm)	1990	2030
	-50% specific energy consumption (per pkm and tkm)	1990	2050
3. EXHAUST EMISSIONS	-40% Total particulate matter and nitrogen oxides	2005	2030
	Zero emissions of particulate matter and nitrogen oxides	-	2050
4. NOISE AND VIBRATIONS	No Longer a problem for the railways	-	2050

The EU has made clear the political imperative of setting medium and longer term targets for the reduction of CO₂ emissions. By establishing its own voluntary strategy, the rail sector reduces the likelihood of having targets imposed on it, and demonstrates that it is a responsible and forward thinking low-carbon mode of transport, whose role should be enhanced as part of the wider move to decarbonise transport. The strategy also provides a framework that allows companies in the rail sector to make long-term plans, using it as a guide, and ensure that the low-carbon advantage that rail has over other modes is retained.

By giving it their approval, the railway organisations and their members have accepted the need to make future plans that follow its contents. With the Environment Strategy Reporting System (ESRS), UIC and CER have developed a monitoring process to ensure that progress is being made in reaching the objectives laid out, and seek to ensure that it aligns the objectives and strategies developed by the EU on reducing the impact of transport. As this is a voluntary strategy, there will be no enforcement process. Given the long-term nature of the strategy, it is also to be expected that it will be reviewed and adjusted during its lifespan, as circumstances change.

The Sustainable Mobility Strategy focuses in particular on the improvement of technological and operational efficiency of current rail activities in the context of wider political changes. It is based on UNEP's transport strategy, with its three primary responses to the challenge of reducing the environmental impact of transport: Avoid, Shift, and Improve. In the context of rail the two most relevant responses are 'shift' and 'improve' - however, rail does have a part to play in 'avoid' strategies within integrated land use and spatial planning.

For more details about EES, it is possible to refer to the energy efficiency and emissions dedicated chapters.

2.3 Other technical strategies

2.3.1 Shift2Rail

Shift2Rail is an initiative included in the framework of the European program Horizon 2020 that is the biggest EU Research and Innovation program ever with nearly € 80 billion of funding available over 7 years (2014 to 2020). Shift2Rail joins the most important players in the European railway sector with the objective to promote R&I (research and innovation) of technological solutions and market driven for new railway products. The goal is to increase the competitiveness of the railway industry and meet the changing needs of the European transport. The route started with Shift2Rail expects to create the technological conditions to complete the single European railway market (SERA).

Shift2Rail born in 2009 from the initiatives of European rail players (coordinated by the Association of the European Rail Industry (UNIFE) which started to think about a strategic policy instrument useful to maintain the European leadership of the global rail market. The conclusion, presented to the European Commission,

was that the leadership of rail market could only be maintained if a critical mass from committed EU industry joined forces to develop innovative, high-capacity and high-quality products. For this reason, the companies supported Shift2Rail that was the natural evolution from EU industrial research cooperation in Horizon 2020. Not least it was clear that realising the ambitious EU transport policy and climate change goals required a massive coordinated investment in rail research.

The core group of European players (not only from the entire rail supply chain, but also those with wider sector expertise) joined the preparation phase on a voluntary basis, and helped build the strong foundation of this public-private partnership. It included:

- **25 major rail stakeholders** were signatories of the Shift2Rail MoU for the preparatory phase, committing to long-term investment in the future of European rail research.
- **More than 60 additional companies** – industrial partners, railway undertakings, urban operators and infrastructure managers – joined the initiative, bringing in their expertise under the framework of the technical preparatory phase.
- **More than 45 universities** and research centres also actively participated in the preparatory phase. Their participation was extremely important, since a significant part of the Shift2Rail budget is to be managed through open calls for proposals that encourage the participation of small and medium-sized enterprises (SMEs) and research organisations. These organisations will have the opportunity to collaborate with the participating companies that are best placed to facilitate the take-up of results.

2.3.1.1 Challenges and objectives

EU research and innovation must therefore help rail play a new, broader role in global transport markets, both by addressing pressing short-term problems that drain rail business operations, and by helping the sector to achieve a stronger market position. The European Commission is working towards the creation of a Single European Railway Area and has promoted a modal shift from road to rail in order to achieve a more competitive and resource-efficient European transport system. However, the share of rail on the European freight and passenger transport markets is still not satisfactory. Moreover there are some of the major issues that the European Union and the wider world are facing (urban sprawl, climate change, congestion, etc.).

Shift2Rail aims to achieve the following goals:

1. Cutting the life-cycle cost of railway transport (i.e. costs of building, operating, maintaining and renewing infrastructure and rolling stock) by as much as 50%;
2. Doubling railway capacity;
3. Increasing reliability and punctuality by as much as 50%.

The project will help boost the competitive edge of the rail supply industry, opening new market perspectives and offering significant employment and export opportunities.

Railway undertakings, infrastructure managers and public transport operators will also benefit from innovations that drastically reduce infrastructure and operating costs. This should also help to reduce the subsidies paid out by national governments – estimated at €36-38 billion in Europe in 2012. Passengers and freight service users will benefit from a step change in the reliability and quality of services. Improved competitiveness and attractiveness of rail services, combined with increased capacity, will help rail take on an increased share of transport demand, thereby contributing to the reduction of traffic congestion and CO₂ emissions. Citizens' health and wellbeing will also benefit thanks to reduced noise pollution from rail.

Figure 3 Countries and cities involved in the Shift2Rail foundation



2.3.1.2 Structure of Shift2Rail

The Shift2Rail Statutes envisage the Shift2Rail Joint Undertaking (JU) comprising the following four main bodies.

- The Governing Board, which has the overall responsibility for the strategic orientation and the operations of the Shift2Rail JU and supervises the implementation of its activities.
- The Executive Director, who is a member of staff of the JU and is responsible for the day-to-day management of the Shift2Rail JU. The Executive Director also manages the Shift2Rail Secretariat.
- The Scientific Committee, which will advise on the scientific and technological priorities to be addressed in the Annual Work Plans (AWPs). This committee is to comprise world-renowned scientists and provide scientific expertise and science-based recommendations to the Shift2Rail JU. It is appointed by the Governing Board, taking into consideration the potential candidates proposed by the States Representatives Group, the European Rail Research Advisory Council (ERRAC) and the European Railway Agency.
- The States Representatives Group, representing EU Member States and countries associated with the Horizon 2020 Framework Programme; inter alia, this group will offer opinions on the strategic orientations of the JU and on the links between Shift2Rail activities and relevant national or regional research and innovation programmes.

Figure 4 Shift2Rail structure

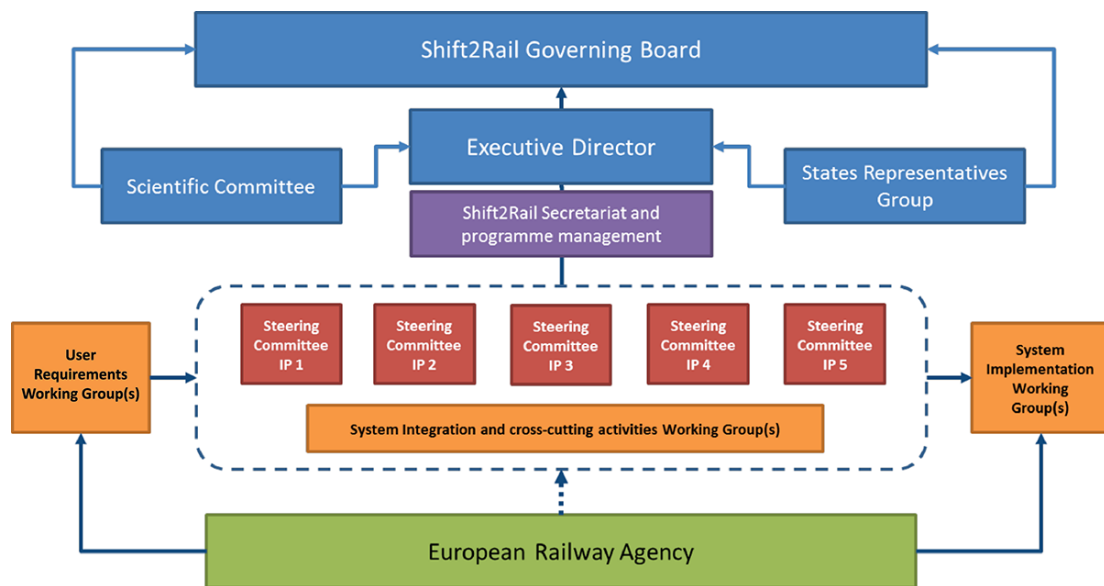

Shift2Rail objectives include promoting an inclusive approach to the widest range of relevant stakeholders, but also ensuring that the Shift2Rail programme pursues a system-wide approach, ensuring the necessary coordination across activities and sufficient focus on end-user needs. With a view to ensuring that the Shift2Rail fulfils these objectives, the Executive Director established the following working groups:

- **User Requirements** Working Group for each Innovation Programme (IP), to specify operational and maintenance-related user needs and to assist the JU in ensuring that technical solutions developed within Shift2Rail meet the specific business needs of end users;
- **System Integration** Working Group to ensure coordination between the activities of each IP and to assist the JU in ensuring that the cross-cutting themes are properly mainstreamed across all IPs;
- **Implementation and Deployment** Working Group to test the operational reliability of the results of Shift2Rail, and with a view to assisting the JU in ensuring the rapid uptake and large-scale deployment of solutions developed through Shift2Rail activities.

2.3.1.3 The Innovation Programmes (IPs)

The work conducted within the Shift2Rail framework will be structured around five asset-specific Innovation Programmes (IPs), covering all the different structural (technical) and functional (process) subsystems of the rail system, namely:

- IP1: Cost-efficient and Reliable Trains, including high-capacity trains and high-speed trains
- IP2: Advanced Traffic Management & Control Systems
- IP3: Cost-efficient, Sustainable and Reliable High-Capacity Infrastructure
- IP4: IT Solutions for Attractive Railway Services
- IP5: Technologies for Sustainable & Attractive European Freight.

These five Innovation Programmes (IPs) form a consolidated assembly of the railway system, with a number of common cross-cutting themes.

Figure 5 Shift2Rail Innovation Programmes and the cross-cutting themes

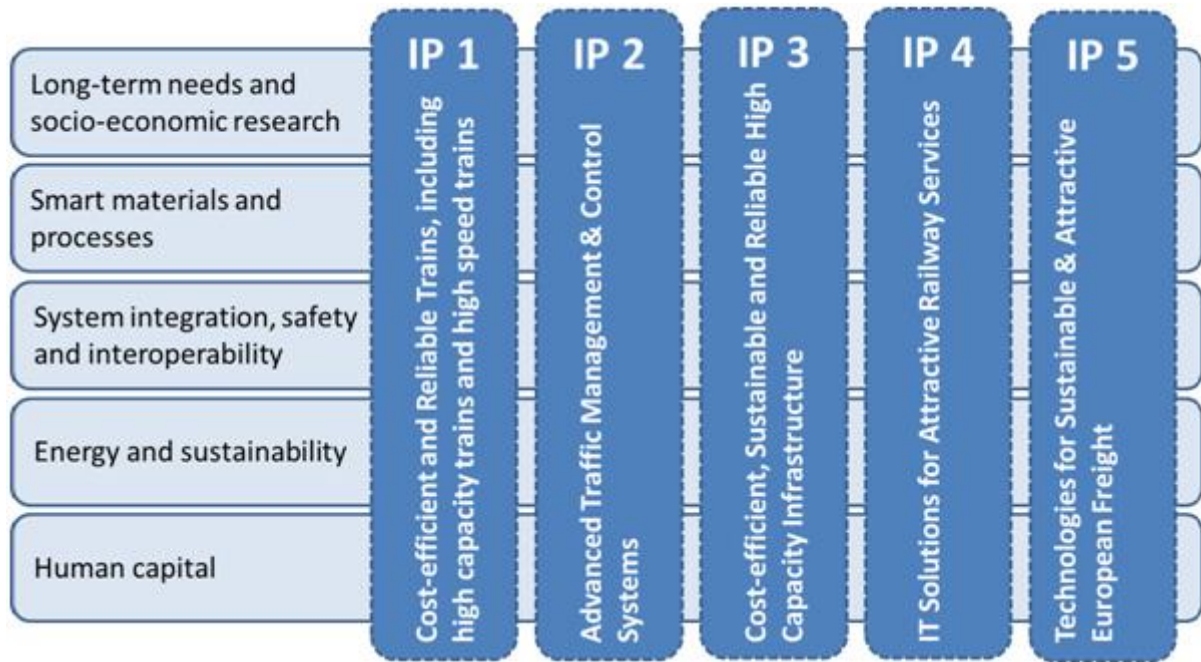

Interactions between the various IPs will be of major importance, given that technological developments in one part of the system could lead to changes in performance or even create barriers in another part of the system managed by another actor. In addition, cross-cutting activities will also include research on long-term economic and societal trends such as customer needs and human capital and skills, which must be taken into account by the different IPs.

Sustainable growth of the rail sector requires a dedicated and balanced approach addressing specific common research and innovation (R&I) challenges, while integrating and demonstrating cooperation between stakeholders across the whole rail value chain.

The Shift2Rail main approach is based on Demonstration activities that represent a priority, as they enable the entire rail sector to visualise and concretely test the transformations that they are able to bring about. Demonstrations also enable a more appropriate quantification of the impact of each new technology (either alone or combined with other innovations). Demonstration activities also help provide a first estimate of the anticipated potential for sector improvement (at regional, national and EU transport network levels) as a result of the developed innovations.

The demonstration of technical achievements will be based on the threefold architecture presented in the figure below:

Figure 6 Demonstration activities approach

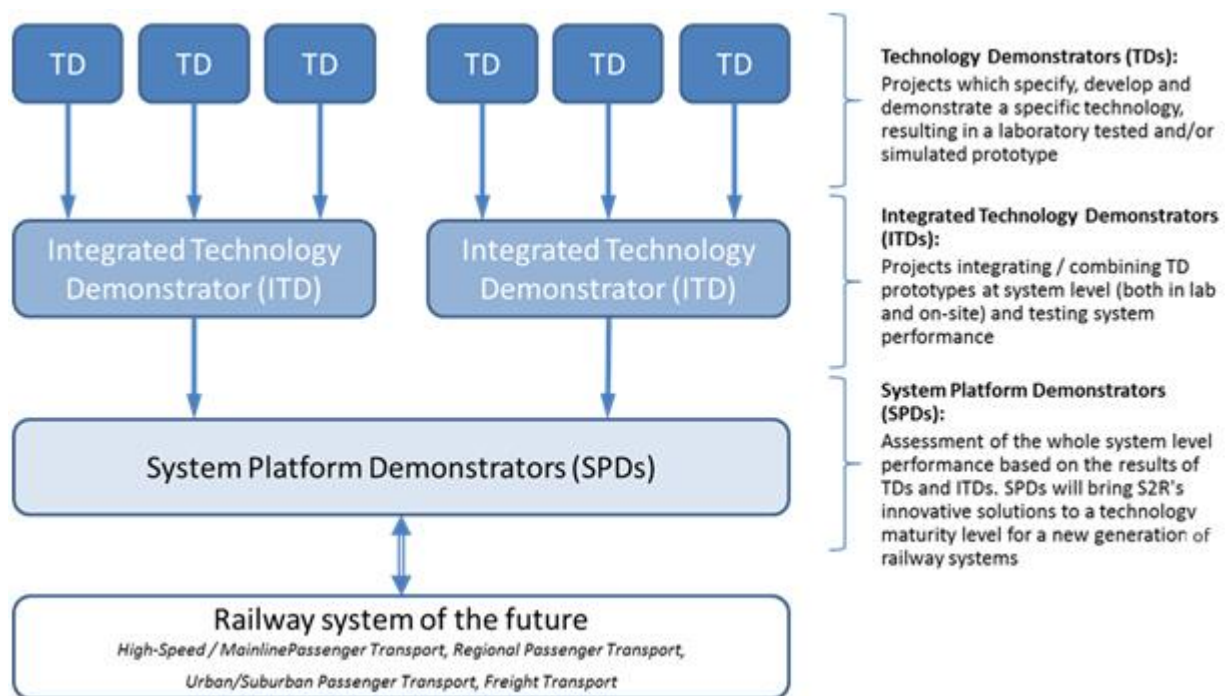

Rolling Stock – Innovation Programme 1

The design of rolling stock plays a key role for the attractiveness of rail transport. Passengers will only prefer to use rail transport over other modes if trains are comfortable, reliable, affordable and accessible. At the same time, the train design must meet the requirements of the railway undertakings and the urban operators (who are the main customers of the rail supply industry), in order to deliver high-quality and cost-efficient services to their customers.

Work will be organised around the following Technical Demonstrators (TDs), covering the R&I following areas:

1. Traction system (TD 1.1)
2. Train control and monitoring system (TCMS) (TD 1.2)
3. The new generation of car body shells (TD 1.3)
4. Running gear (TD 1.4)
5. New braking systems (TD 1.5)
6. Innovative doors (TD 1.6)
7. Train modularity in use (TD 1.7)

Signalling – Innovation Programme 2

Control, command and communication systems should go beyond merely being a contributor to the control and safe separation of trains, and become a flexible, real-time, intelligent traffic management and decision support system. Current systems do not sufficiently take advantage of new technologies and practices, including use of satellite positioning technologies, high-speed, high-capacity data and voice communications systems (Wi-Fi, 4G/LTE) and automation, as well as innovative real-time data collection, processing and communication systems. These have the potential to considerably enhance traffic management (including predictive and adaptive operational control of train movements), thereby delivering improved capacity, decreased traction energy consumption and carbon emissions, reduced operational costs, enhanced safety and security, and better customer information.

Work will be organised around the following Technical Demonstrators (TDs):

1. The development of a new Communication System (TD 2.1)

2. Automatic Train Operation (ATO) (TD 2.2)
3. Moving Block (TD 2.3)
4. Safe Train Positioning (TD 2.4)
5. Train Integrity (TD 2.5)
6. The development of a new laboratory test framework (TD 2.6)
7. The development of a set of standardised engineering and operational rules (TD 2.7)
8. Virtual Coupling (TD 2.8)
9. An optimised Traffic Management System (TD 2.9)
10. Smart radio-connected all-in-all wayside objects (TD 2.10)
11. Cyber Security (TD 2.11)

Infrastructure – Innovation Programme 3

The design, construction, operation and maintenance of rail network infrastructure has to be safe, reliable, supportive of customer needs, cost-effective and sustainable. Furthermore, to deliver the benefits of market opening and interoperability and to reduce the life-cycle costs of rolling stock and on-board signalling systems, there needs to be a (gradual) elimination of network diversity through a migration towards a common high-performing infrastructure system architecture.

Work in IP3 will be organised around the following Technical Demonstrators (TDs):

1. Enhanced Switch & Crossing System (TD 3.1)
2. Next Generation Switch & Crossing System (TD 3.2)
3. Optimised Track System (TD 3.3)
4. Next-Generation Track System (TD 3.4)
5. Proactive Bridge and Tunnel Assessment, Repair and Upgrade (TD 3.5)
6. Dynamic Railway Information Management System (DRIMS) (TD 3.6)
7. Railway Integrated Measuring and Monitoring System (RIMMS) (TD 3.7)
8. Intelligent Asset Management Strategies (IAMS) (TD 3.8)
9. Smart Power Supply (TD 3.9)
10. Smart Metering for Railway Distributed Energy Resource Management System (TD 3.10)
11. Future Stations (TD 3.11)

Passenger Services – Innovation Programme 4

To become a more attractive option, rail must respond to customer needs to support anytime, anywhere, door-to-door, intermodal journeys encompassing distinct modes of transportation. Rail must achieve interoperability with other transport modes and mobility services, with regions, cities and people engaged in social and economic activities, and with the key elements of the supply chains which can make rail products and services available to those people. In order to achieve this, rail needs to take due advantage of the increasing connectivity of people and objects, the availability of European Global Navigation Satellite Systems (GNSS)-based locations, the advances in cloud computing, big, linked and open data and the propagation of internet and social media. The step towards sharing data needs to be considered and progressively developed, in order to enable service developers to provide connected travellers with the services they need and expect.

Work in IP4 will be organised in the following TDs:

1. Interoperability Framework (TD4.1)
2. Travel Shopping (TD4.2)
3. Booking & Ticketing (TD4.3)
4. The 'Trip-tracker' (TD4.4)
5. Travel Companion (TD4.5)
6. Business Analytics (TD4.6)

Freight – Innovation Programme 5

Although rail freight markets within the EU have been open for a number of years, the modal share of intra-EU rail freight transport has slightly declined in the past decade. It is important that future rail freight solutions are developed to optimise the overall transport time; this includes cutting down on handling and set up times at marshalling yards and in terminals, and stepping up the average speed for rail freight operations (even including, for certain market segments, an increase of the top speed). All innovation activities should also ensure that rail freight is able to better operate in conjunction with passenger traffic, in order to maximise the utilisation of existing networks.

Work in IP5 will be organised around the following Technical Demonstrators (TDs):

1. Freight Electrification, Brake and Telematics (TD 5.1)
2. Access & Operations (TD 5.2)
3. Wagon Design (TD 5.3)
4. Novel Terminal, Hubs, Marshalling yards, Sidings (TD 5.4)
5. New Freight Propulsion Concepts (TD 5.5)
6. Autonomous train operation (TD 5.6)

3 Key Environmental Requirements of Railway

3.1 Energy Efficiency

The energy efficiency in the railway sector is highly correlated with the reducing carbon dioxide emissions and in most cases these issues are two sides of the same coin. For simplicity and clarity of the discussion there are two separate chapters. To avoid duplication, certain issues are included in a chapter rather than another. We have followed the principle that the issues relating solely to the reduction of CO₂ are included in the dedicated chapter.

3.1.1 Current situation

In 2012 energy consumption due to rail transport in Europe accounts for only 1.3% of the total energy consumption from transport sector, representing the 0.4% of the total energy consumption in Europe. The rail share results to be much lower than the weight of railways in the modal split, thanks to a lower specific consumption compared to other transport modes.

Figure 7 European share of final energy consumption by sector, 2012

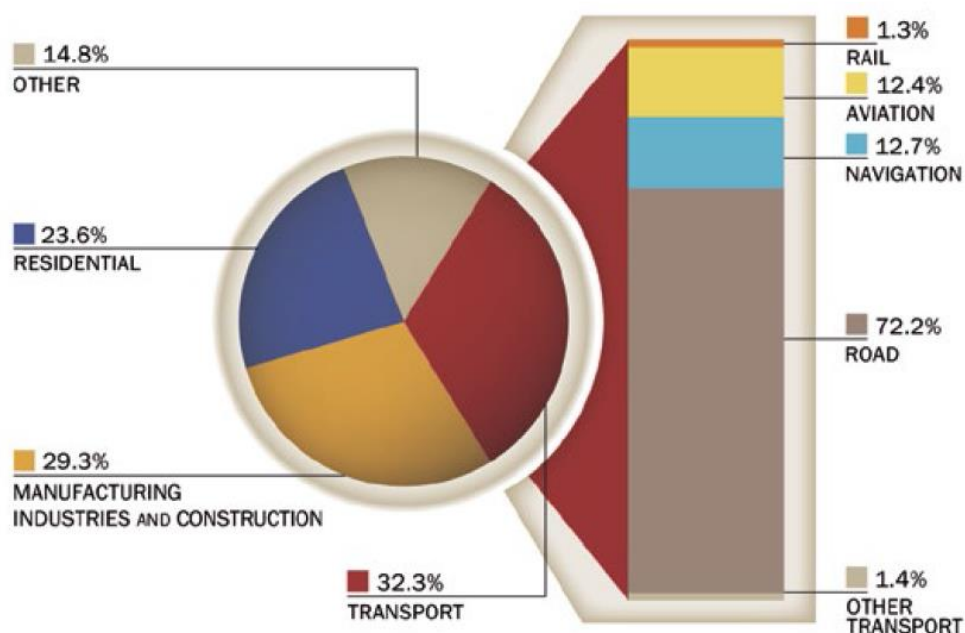

Source: UIC IEA Handbook 2015

In absolute values, the total energy consumption from European railway sector was equal to 52 TWh in 2013. This value has been decreasing by about 30% respect to 1990 levels, considering the amount of passenger-km increased by 9% and the number of tonnes-km decreased by 52% in the same period.

Figure 8 European railway sector total energy consumption, 2013 (TWh)

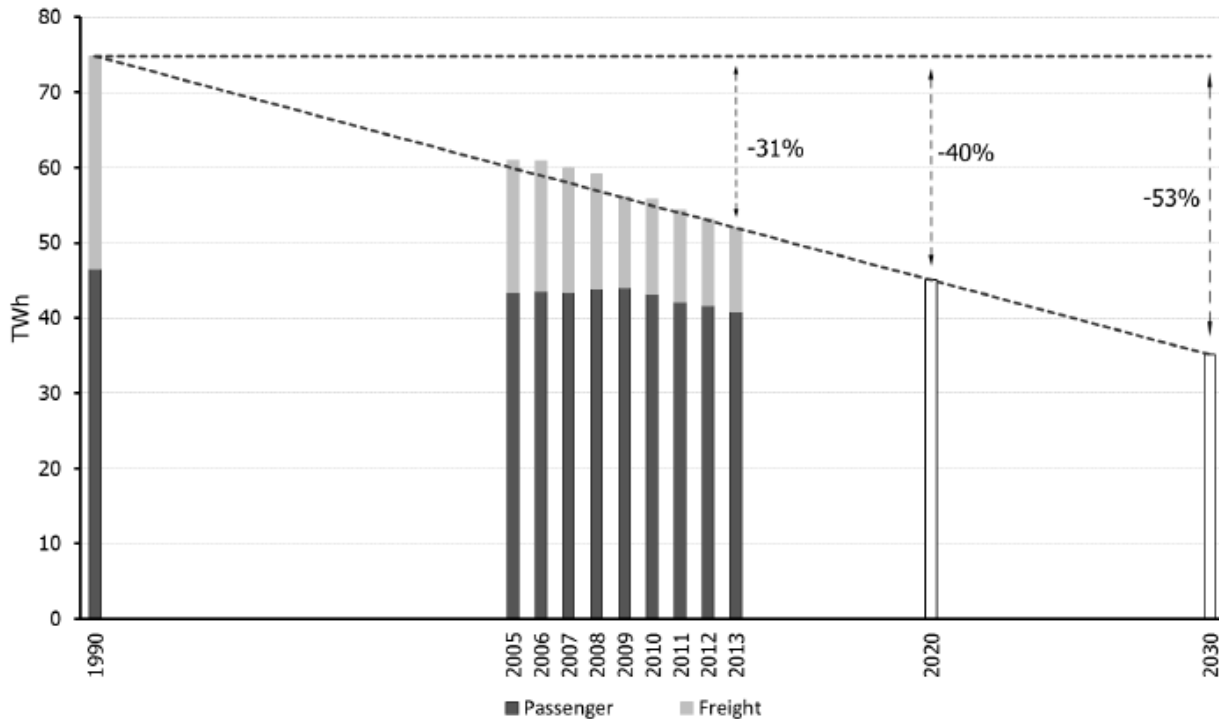

Source: UIC 1990-2030 Environment Strategy Reporting System – 2015 Report

In specific terms, the European rail sector shows in 2013 a value of 0,107 kWh for passenger km and 0,051 kWh for tonne km. By comparing the indicator of energy intensity with different regions of the globe, the European railway sector has low to mid rates of energy intensity, both in passenger and in freight transport. In the passenger sector, energy intensity values are higher than world averages, while in the freight sector those values are in line with the average of main railway companies of the world.

The energy efficiency performance of the European rail sector has been constantly improving: the energy needed for moving a passenger over a km has been decreasing by 19,6% respect to 1990 values, while for the freight sector the reduction is about 22% respect to 1990 levels.

The EU rail sector committed to energy consumption reduction targets, aiming to cut the energy consumption per pkm and tkm by 20% in 2020 and by 30% in 2030. The current situation shows that the energy efficiency performance is on line with the UIC ESRS targets as shown in figures below.

Figure 9 Trend of specific energy consumption for passenger (upper graph) and freight services (graph below), also related to the 1990 values and the 2030 Strategy Target

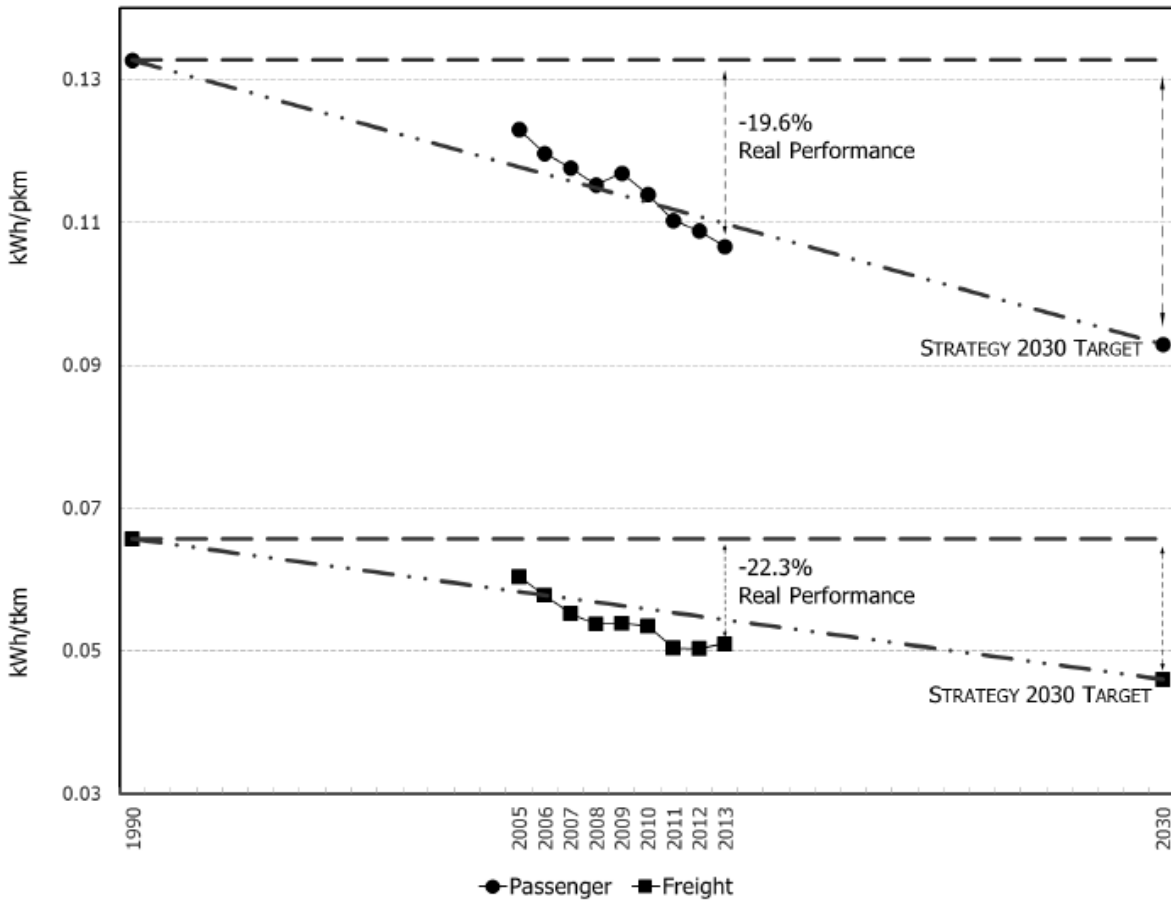

Source: UIC 1990-2030 Environment Strategy Reporting System – 2015 Report

The trend shown above refers to the European average. Within the different rail systems there are many differences, both in terms of energy intensity and in terms of reduction trend. The following figure shows the specific energy consumption, for passenger and freight, for some of the main European companies.

Figure 10 Specific energy consumption railways benchmark, 2012 (blue line = kWh/pkm; red line = kWh/net tonnes km)

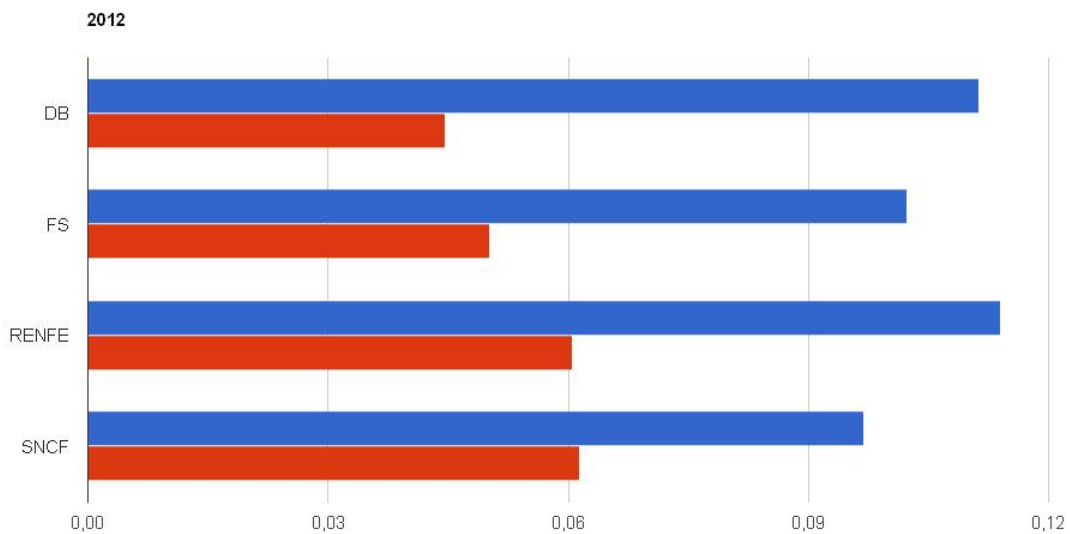

Source: UIC CO₂-data.org (confidential, for UIC members only).

3.1.1.1 Past trends energy efficiency drivers

Accordingly to an extension of UIC-CER ESRS 2014 report, with the goal of understanding which railway companies have contributed the most to the progress towards the environmental objectives fixed for 2020 and 2030, as can be seen (see figure below), for passenger service, the German company Deutsche Bahn contributes the most to the reduction of European specific energy consumption, due both to the size of its production (20% of European passengers are transported by DB) and to an important improvement in energy efficiency during last years. Even a small reduction of specific energy consumption in German railways would have a significant impact on the reduction of specific energy consumption across Europe. In this case DB reduction in specific consumption from 1990 was also more than double the reduction of any other railway.

Figure 11 Reduction of specific energy consumption for passenger (kWh/pkm, left) and freight (kWh/tkm, right) with the contribution attributed to each European railway company

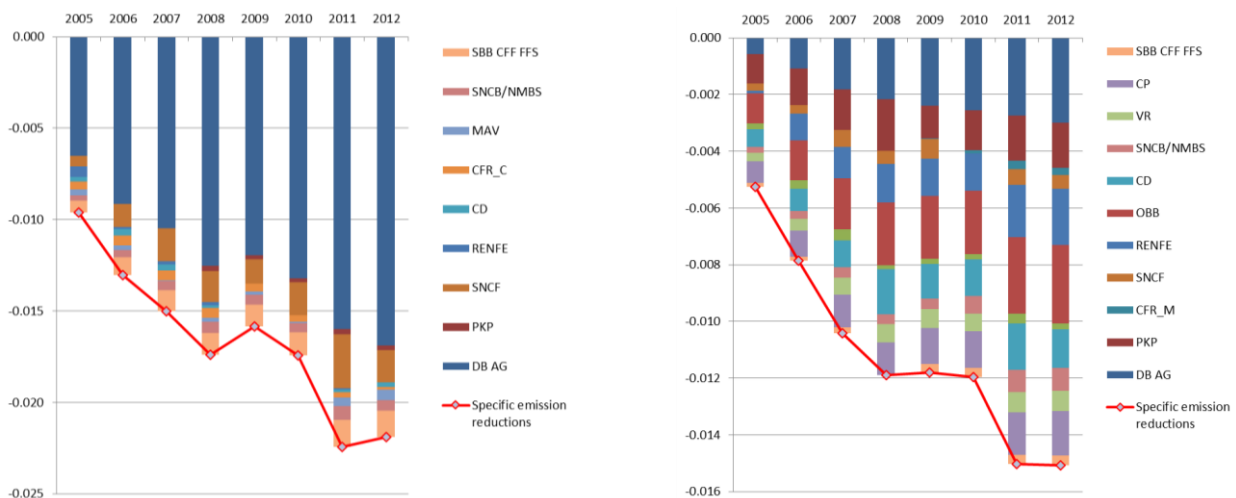

Source: UIC/CER, Energy and emission reduction drivers for European railways, 2014

For freight, the picture is a bit more varied, with other railways (such as OBB, RENFE, PKP, CP and CD) giving significant contributions to the improvement of energy efficiency in European railways.

As part of the same project, in 2014 a survey addressed to railway companies has been commissioned by UIC¹ in order to identify the main energy efficiency drivers that led to this increasing of the performance and as well investigating which will be the main factors in the agenda of Railway Operator for the coming years.

The questionnaire, between others, included questions on:

- Energy performance strategy (whether a formal strategy exists in the railway);
- Reduction performance: expectation of reduction of energy consumption by 2020 and 2030 (whether a formal strategy exists or not);
- Energy measurement: whether energy is measured and how;
- Reduction drivers: what were the drivers for the reduction of energy consumption in the past 15 years and what they will be in the next 15 years.

The European railways which have responded to the questionnaire represented 291.5 billion passenger-km of production in 2012, which is around 75% of all European passenger production recorded in UIC statistics, and 220 billion tonnes-km (79% of European freight production recorded in UIC statistics for 2012). It is important to note, however, that some of the biggest European railways (e.g. ATOC and RENFE) have not responded to the questionnaire at all, while other large railways (e.g. DB and SNCF) have given incomplete answers in some sections.

The energy consumption reduction drivers suggested in the questionnaire were:

- Heating, cooling and “train hotel loads” management;
- Eco-driving programs/use of DAS;
- Infrastructure energy efficiency management;
- Increase of regenerative braking;
- More efficient rolling stock;
- Load factor/empty trips management.

Regarding the main drivers contributing to the reduction of energy intensity the results of the survey shows that for passenger service, the major driver in specific energy consumption reduction is more efficient rolling stock, while for freight it is the management of load factor and empty trips².

¹ UIC Technical study "Energy and emission reduction drivers of European Rail sector", (2014)

² In the next 15 years the attention will be concentrated in Load factor improvement followed by more efficient rolling stock, Ecodriving and DAS, regenerative braking, infrastructure and hotel loads management

Figure 12 Main results of UIC survey

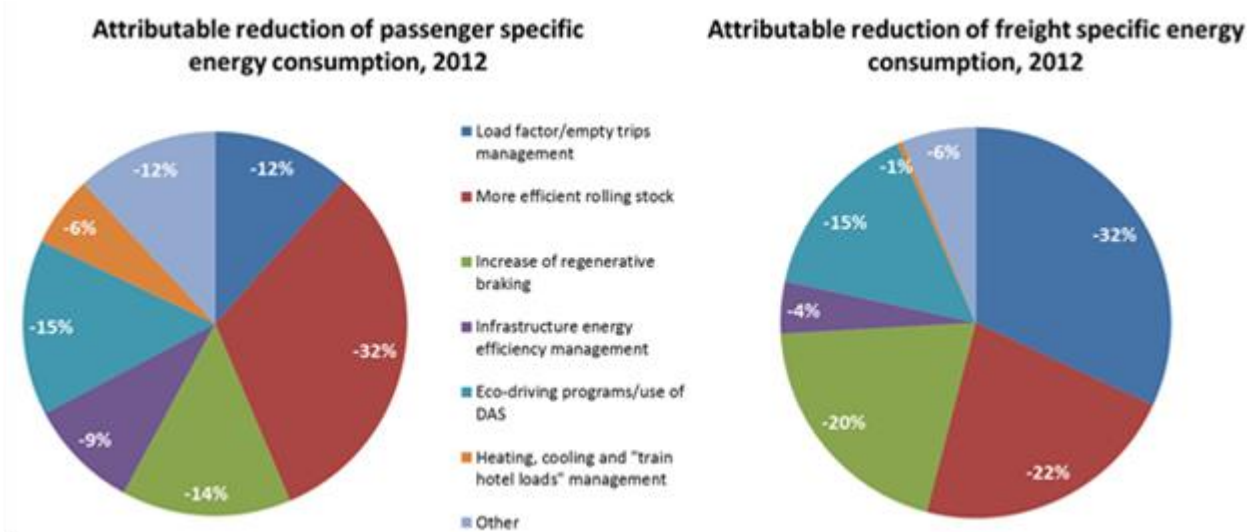

Source: UIC/CER, *Energy and emission reduction drivers for European railways, 2014*

Indicators are defined according to the objectives to be achieved and the evaluation context. When it is necessary to compare the energy consumption of the rail mode with other modes of transport, the energy intensity is the most significant indicator.

The *Railenergy* project has established some key indicators with the aim of seizing the performance of technologies and measures proposed and evaluated during its activity. The following Key Performance Indicators (KPIs) have been defined, in accordance with the approach of the UIC leaflet 330 "Railway specific environmental performance indicators":

- KPI 1 - *Final Energy consumption per traction effort* (Final net energy consumption measured at the point of common coupling/Total Mass x km)
- KPI 2 – *Final Energy consumption per offered transport* (Final net energy consumption measured at the point of common coupling/seat offered x km)
- KPI 3 – *Primary Energy consumption per actual traffic output*³
- KPI 4 – *Final Energy consumption per actual traffic output* (Final net energy consumption measured at the point of common coupling/number of passengers or tonnes x km)
- KPI 5 – *Share of energy consumption for parked trains* (Energy consumption of trains in parked mode measured at the pantograph/Final net energy consumption measured at the point of common coupling)
- KPI 6 – *Energy recuperation rate* (Recuperated energy of trains measured at the pantograph/ Final gross energy consumption measured at the point of common coupling)
- KPI 7 – *Efficiency of the railway distribution grid* (Final net energy consumption measured at the point of common coupling/ Net energy of trains in operation mode measured at the pantograph)

The performance of European railway sector in terms of energy for passenger-km or tonnes-km refers to the KPI 4. Using other indicators, i.e. KPI 1 and KPI 2, the performance of the European railway sector represents a different picture: both for passenger and freight the trend of Final Energy consumption per traction effort is stable, with no significant improvement in the latest years.

³ Not calculated anymore

Figure 13 EU 28 passenger total energy consumption (MJ) per gross tkm, 2005-2012

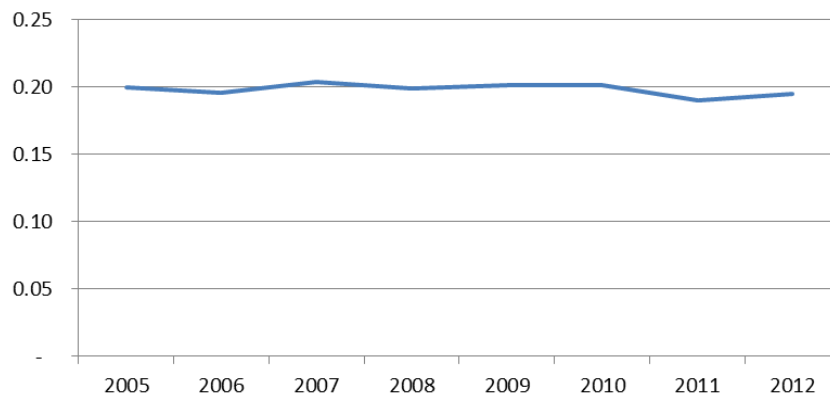

Source: Elaboration by Sustainable Development Foundation based on UIC data (confidential, for UIC members only)

Figure 14 EU 28 freight total energy consumption (MJ) per gross tkm, 2005-2012

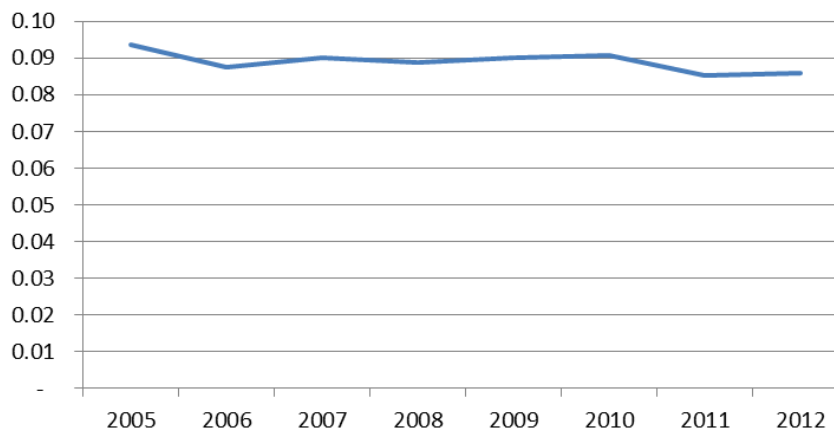

Source: Elaboration by Sustainable Development Foundation based on UIC data (confidential, for UIC members only)

It's necessary to underline anyway that important data are lacking, both for electricity and for diesel, thus the EU curve is not very representative of the real situation. The railways for which the gross tkm data are available account for about 35% of total European passenger activity.

Also taking in account the total final Energy Consumption per seat offered, in the period 2005-2012, the trend does not show any significant variation over the period, while the energy intensity indicators measured for passenger-km and tonnes-km show significant improvements during the same time.

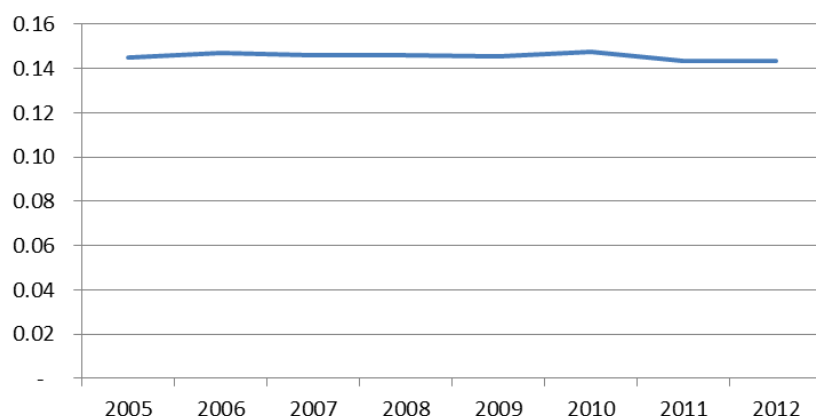
Figure 15 EU28 Total energy consumption (MJ) per seat-km, 2005-2012

Source: Sustainable Development Foundation elaboration based on UIC statistics and ESRS data (confidential, for UIC members only)

This analysis suggests that probably the perception by the railway companies about the major factors reducing the specific energy consumption is not sufficiently reliable. This aspect requires an in-depth analysis and also suggests an alternative interpretation.

As noted earlier, the energy intensity can be influenced by the load factor of trains, expressed as the ratio of satisfied demand (output) and production (input). The re-organisation process started in Europe between the years 80s and 90s and the shift from a model of national state-owned railway to more competitive market oriented railway companies⁴ is strongly correlated with the reduction/rationalisation of transport services with the aim to increase load factor and profitability as well. In other words, the improvement in the railway occupancy rate required by a more competitive context, probably led to better railway companies economic performance as well to energy efficiency.

Furthermore European railways are actually the transport mode with the highest rate of electrification (61% in 2012). The electrification share of EU railway sector is constantly increasing since the 70' and in 2013 reached about the 60% of the total railway lines length.

⁴ The railway market reform, operated firstly in England in the mid-eighties and later in EU by Directive 440/90, focused on break the railway natural monopoly and the introduction of competition within the market (multi-operator) and for the market (bidding for exclusive right to operate).

Figure 16 European length and share of electrified versus non-electrified railway tracks, 1975-2012 (thousand km)

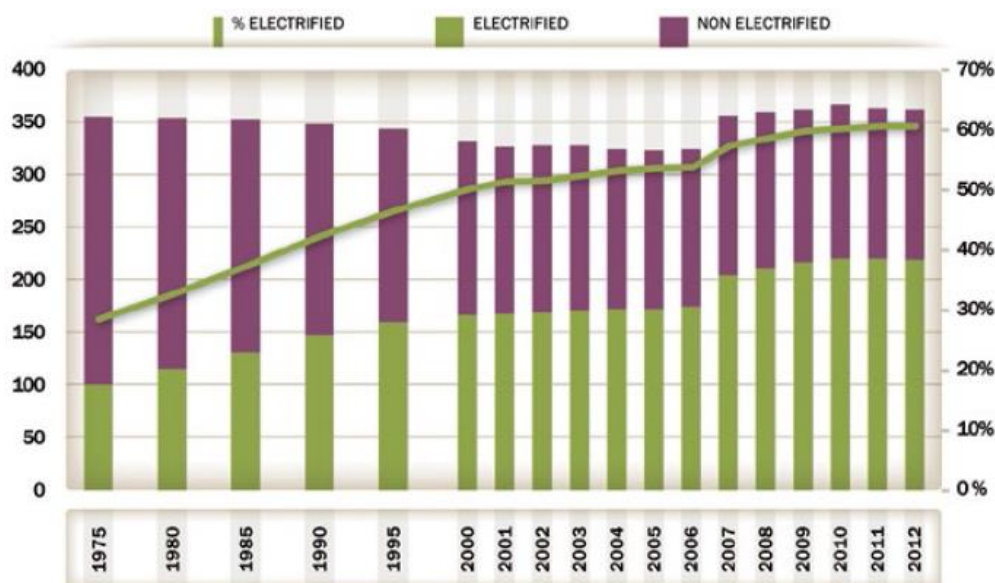

Source: UIC IEA Handbook 2015

In terms of energy consumption, the proportion of electricity consumption compared to those related to other power sources (coal and diesel) have also grown steadily: in 1990 the share of electricity accounted for 62% while 71% in 2013. As we will see in the next chapter this aspect, that is energy efficiency related, has significant repercussions in the field of CO₂ emissions, varying with the energy mix present in each European country.

3.1.2 Challenges and limitations

3.1.2.1 The challenge of complexity

The challenge posed by the issue of energy efficiency on the railways is to deal with complexity. Strategies, measures and technologies potentially adoptable to increase the energy efficiency of rail system cover a wide range of actions, reflecting the extreme complexity of the railway sector. Some of them are purely related to technological improvement, others to a different organization of the production processes, and others to the interaction with the market regulations and transport demand.

To describe how the main strategies and measures adopted by the European rail system for energy efficiency have evolved towards ever more complex approach, this chapter investigates the concept of three “flagship” research projects developed by UIC or with UIC cooperation: *Event*, *RailEnergy* and *Merlin* project. The main task of these projects has been to evaluate the main measures and technologies in energy efficiency, with the goal of providing a strategic framework to the railway companies, to the industrial sector and European institutions.

Figure 17 EU projects timeline for energy efficiency

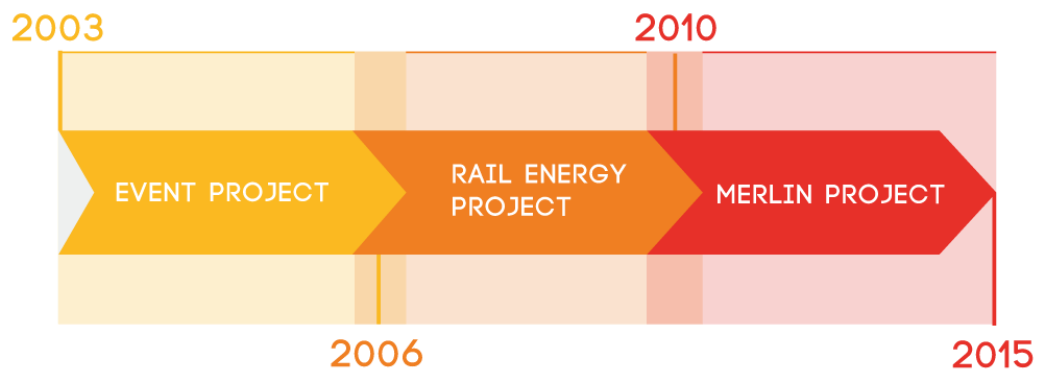

Considering how these projects were carried out in succession, covering a period from the early 2000s until today, a brief description of the main topics investigated and the conclusions that have been reached in each project will provide a picture of the main energy efficiency strategies and measure for the European railway system as a whole.

UIC EVENT Project⁵

The key aim of EVENT was to provide a global state-of-the-art overview over energy efficiency technologies and their technological, economic and environmental potential. Furthermore, key success factors and impeding factors for the dissemination of these technologies in railways were analysed, providing recommendations for implementation strategies and lanes of action for all relevant technology fields.

Figure 18 EVENT scope of study

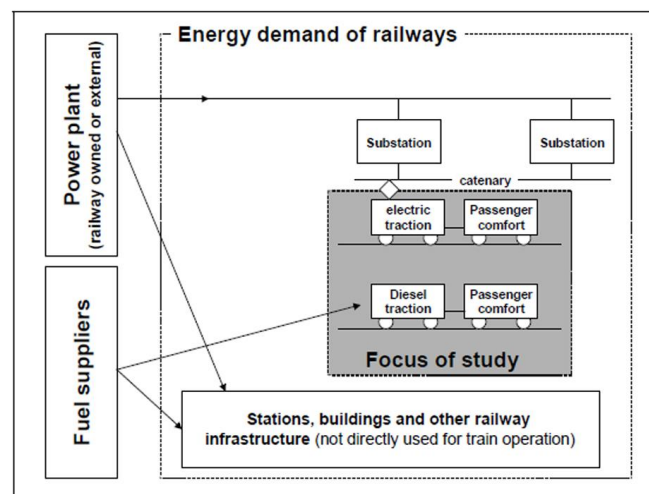

Source: ITZ

At the end of the project in 2003, the conclusions of the project were:

- The potential of individual technologies or measures is mainly determined by
 - the possible energy savings to be achieved (**technological issue**)
 - the chances for implementation (**operational issue**)

⁵ EVENT Evaluation of Energy Efficiency Technologies for Rolling Stock and Train Operation of Railways - Final Report submitted to the Subcommission Energy Efficiency, Berlin, March 2003. The Subcommission Energy Efficiency (SCEE) of the CTR Committee of the UIC commissioned the Berlin-based IZT to realize a two-year project on energy efficiency technologies and strategies for Railways. The Railway Environment Centre of Deutsche Bahn AG was responsible for the Project Management.

- Whereas technological improvements to rail vehicles will be rather incremental and require a long time for diffusion, there are many short- and medium-term saving measures aiming at an optimised control and use of present technologies or operational improvements;
- Innovative traction technologies, the integration of energy efficiency targets into vehicle strategies and the focus on more systemic approaches such as telematics-based traffic management will have a great potential just in a long term perspective;
- In short term energy efficient driving strategies are the most promising single approach to save energy in train operation. Improved traffic fluidity and systemic optimisation as for example a future traffic management system linked to the on board driving advice units in the trains helpful to avoid a good share of unnecessary stops at signals it's a long term perspective strategy.
- Another very promising approach for reducing seat-specific energy consumption is double-decked and wide-body rail vehicles (if infrastructure gauge limit allows this measures);
- Regenerative braking is a promising field of action for energy efficiency. In AC systems considerable improvements are to be expected from drivers' sensitisation and training programmes. In DC systems, the theoretical potential is even higher but can only be exploited by high investments in storage and/or inverter technology, which are only profitable in contexts with an especially high saving potential;
- The traction system of modern state-of-the-art rail vehicles shows a high degree of energy optimization already both for electric and diesel propulsion. However, the market stage of most of these developments will only come in the next decade;
- Comfort functions take a smaller share in total energy consumption than traction equipment but arguably offer more technological optimisation potential. Especially the optimisation of comfort functions in parked trains is very promising particularly in cold climate zones;
- The energy efficiency of railways is not only determined by the pace of technological progress but by a number of framework conditions inside and outside railway companies:
 - *Payback and profitability* are decisive factors for the technology implementation;
 - The *deregulation of railway markets*, that has indirect effects on energy efficiency technologies;
 - Many technologies cannot be introduced by railways themselves but rather have to be integrated by manufacturing companies into the design of rolling stock. *Procurement and standardisation* are crucial factor to improve energy efficiency.

Railenergy project

Railenergy has been an integrated project co-funded by the European Commission under the 6th Framework Programme for Research and Development⁶. The main objective of *Railenergy* project was to address energy efficiency of the integrated railway system and to investigate and validate solutions ranging from the introduction of innovative traction technologies, components and layouts to the development of rolling stock, operation and infrastructure management strategies.

The recommendations issued from *Railenergy* project were collected focusing on three different application areas (operational measures, rolling stock and infrastructure), classified according to the four different main traction systems of the European continent (Direct Current Railway Services, Alternating Current for suburban/regional/intercity/freight service, alternating Current for High-Speed service, Diesel Railway Services).

The following single technical component assessed per main traction system was investigated in terms of technology description, energy saving potential, advantages and range of application.

⁶ The full name of the project is "Innovative Integrated Energy Efficiency Solutions for Railway Rolling Stock, Rail Infrastructure and Train Operation." The starting date of the project is 1st of September 2006, and the duration was four years.

Table 2 The Railenergy investigated technologies

Railway Domain	Technologies and measures
Operation	Energy Efficient Train Operation (EETROP) - Eco-driving (Level 1): Driver training
	Energy Efficient Train Operation (EETROP) - Eco-driving (Level 2): Driver advice system
	Energy Efficient Train Operation (EETROP) - Eco-driving (Level 3): Fluid traffic management
Infrastructure	Reversible DC substation
	Real-time management
	2x 1.5 kV DC traction system
	Asymmetrical AT system
	Parallel substation
	Increased line voltage
	Reduced line impedance
Trackside energy storage	
Rolling Stock (on board components, traction or optimisation)	Onboard energy storage
	Waste heat usage by using absorption refrigeration
	Superconducting Traction Transformer System
	Medium frequency traction power supply
	Hybrid diesel electric propulsion with permanent magnet synchronous machines
	Reduction of vehicle coasting loss
	Active filtering technology to reduce input passive filter losses
Optimised management of medium voltage loads for energy saving	

Source: Railenergy

Following this conceptual matrix, the project has mapped the various intervention measures in accordance with a degree of greater and lesser complexity (component/system) and according to the possible implementation time required. Figure 11 shows the five maps that briefly display various measures considered, with operational measures displayed in a single map grouping all different traction system. A scale of colors from light green to darker green also highlights the measures according to different payback times.

Figure 19 Measures Complexity and Time Horizon

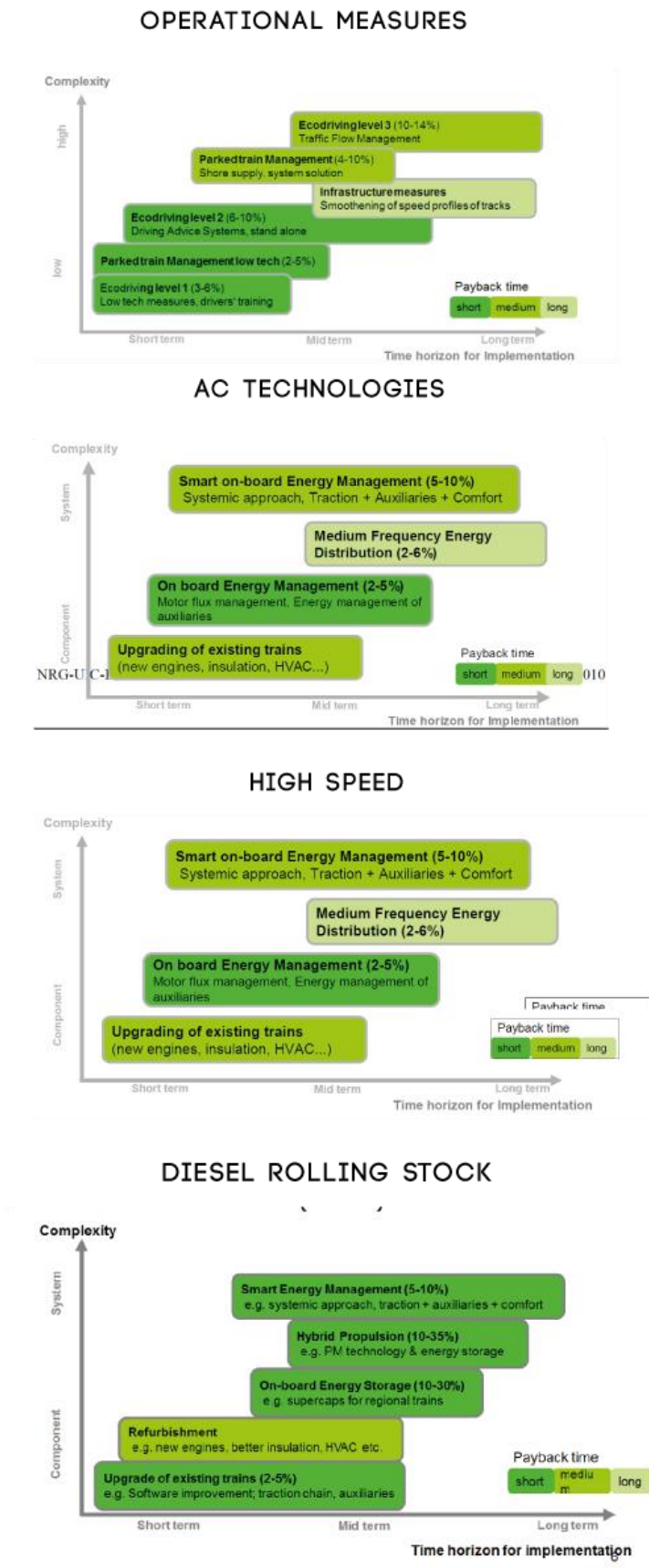

Source: E.Wiebe, J. Sandor 2010

MERLIN project

MERLIN has been co-funded by EU 7th Framework Programme of the European Commission and it has been coordinated by UNIFE under the technical leadership of CAF. The project has finished in 2015.

MERLIN's main aim and purpose is to investigate and demonstrate the viability of an integrated management system to achieve a more sustainable and optimised energy usage in European electric mainline railway systems. In other words, the Merlin project intends to apply a holistic approach to the issue of energy management. The project builds a complex system architecture in which it is possible to understand the cross-dependencies between technological solutions and to improve cost effectiveness of the overall railway system.

Merlin has proposed an integrated optimisation approach that includes multiple agents, dynamic forecasting and cost considerations to support strategic and operational decisions following this path.

- As a first step, the project has developed first the reference architecture of a railway smart grid concept namely REM-S, including its functions, interfaces, components and protocols.
- Secondly a strategic decision making tool (SDMT) based on this architecture have been developed to support the design of the rail smart grid. The tool takes into account the business constraints and suggests modifications for the system layout after analysing (by simulation) the scenario during a complete running cycle. The proposed architecture and tools have been evaluated in the high-speed, freight, regional, commuter and mixed freight-passenger traffic scenarios to assess improvements in subcontracted power, consumed energy and costs.
- Third, a pilot case of this integrated approach has been deployed in the suburban network of the Spanish city of Malaga for evaluation and assessment to show the potentials of MERLIN's concept under real operational conditions.
- Last, MERLIN has issued a number of technical recommendations and implementation guidelines to facilitate the market uptake of the project concepts and results.

Figure 20 Merlin project according to its main stages

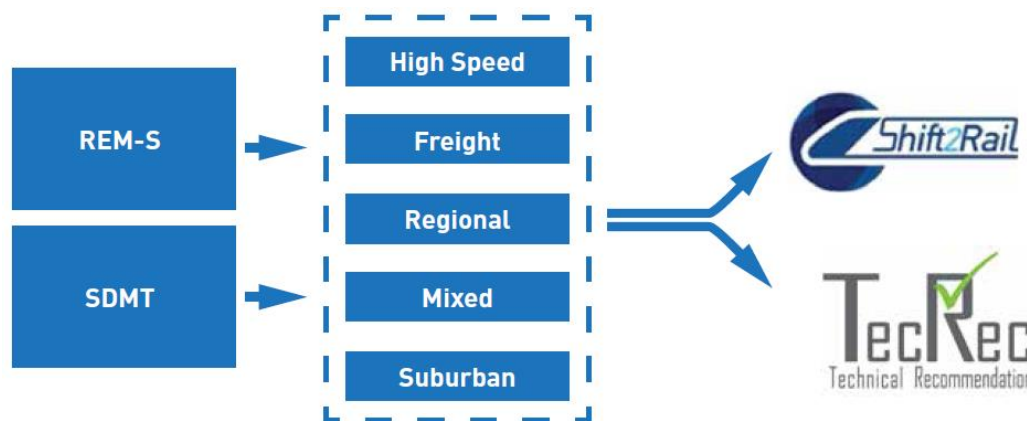

Source: Merlin

It's possible to seize a line of development that connect the three projects mentioned above. There is a shift from the evaluation of single measures and technologies to an increasingly holistic and systemic approach: the economic evaluations are more and more stringent, the specific context in which the companies operate is taken into account, the relationship between the transportation and the energy markets are considered.

With regard to the railway sector, the issue of the boundaries of a strategy to reduce energy consumption is puzzling and questionable. The boundaries can be very narrow and limited to those policy areas which are under the control of Railway Operator.

In the framework of the European market of railways, already the separation between transport services and infrastructure management poses many problems of integration and coherence. The same railway

companies can operate in fully liberalized market segments and in others where there is still a strong commitment of the State. In Europe, investments in infrastructure are under governmental jurisdiction (national and local), therefore any technological improvement is linked to choices that do not directly compete with the railway companies. Similarly it is the investment in new rolling stock for local transport services.

In the chapter devoted to CO₂ emissions, the issue of boundaries is further deepened. Some of the key factors in reducing CO₂ emissions fall outside the scope of the railway sector and fall within the framework of energy policies and transport policies as a whole.

3.1.2.2 The modal shift challenge

Energy efficiency is a key challenge for today's railway companies for reasons of cost effectiveness and environmental protection. From the environmental point of view, the real challenge of railways is not just to reduce their specific impact on energy consumption, but to expand their market share.

As seen in the first paragraph, currently the energy consumption of railways are substantially lower than other transport modes: therefore, rail is one of the transport modes towards which mobility has to be *shifted*.

It will be very important in the coming years to ensure a sustainable compromise between the need to continue increasing the attractiveness of trains for the customers on one hand and the need to prevent an uncontrollable growth of energy consumption on the other hand.

The expansion of the high speed case is a good example to understand the challenges facing the railways in the near future. This kind of railway service may on first inspection appear to lead to an increase in energy consumption. It is true that the energy required to overcome aerodynamic drag increases exponentially with the speed of the train. However, high speed rail systems typically achieve energy savings in a number of other areas (e.g. lower mechanical resistance, energy lost in braking, electrical losses, etc.). When the performance of the whole system is analysed it is clear that high speed rail services can consume lower quantities of energy when compared to conventional rail⁷.

Empirical data from the European experience confirms the hypothesis that high speed trains have a lower energy intensity compared to intercity and regional trains. As an example, a comparison between specific consumption of different train types of Spanish company RENFE- in normal operating environment -shows that energy intensity per pkm is inversely proportional to the speed of different train types.

⁷ Alberto GARCIA, High speed, energy consumption and emissions: study and research group for railway energy and emissions, Paris 2010

Figure 21 Comparison of energy consumption per passenger-kilometer in various types of trains (energy 100= 140 Wh and speed 100= 160 km/h)

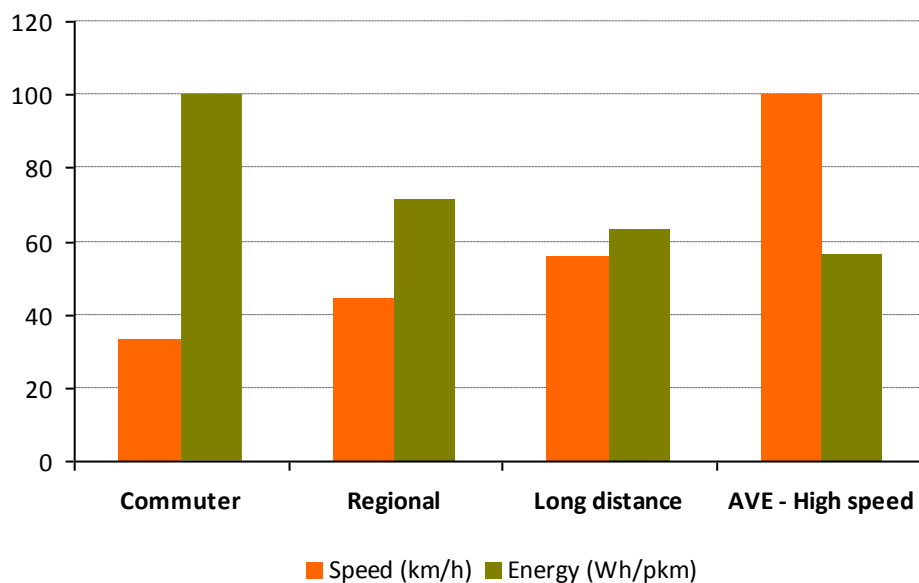

Source: UIC/RENFE

The popularity of this type of HSR service is such impressive that the load factor of the trains is extremely high. Consequently, as explained in the previous paragraph, the energy intensity is affected positively.

This modal shift challenge is concretely manifested in the form of “Low carbon transport challenge”, presented to United Nations Secretary General's Climate Summit in 2014 and then reinforced with commitments by individual member companies in Paris on December 2015 where over 70 CEOs from railway companies across the world signed the Railway Climate Responsibility Pledge.

The “Low carbon transport challenge” set out a vision for the global rail sector with different targets divided in two pillars. The first pillar concerns energy and carbon intensity reduction while the second pillar of the challenge concerns shifting transport activity towards low carbon rail transport (modal shift).

To date, the limitation of this expansionary strategy is the energy impacts in LCA perspective. In order to gain market share, it is necessary to increase the capacity of the railway network and increase the supply of services. All this involves upstream and downstream energy consumption of the transport activity.

3.1.3 Recommendation

Taking into account the general objectives of this report, the recommendation issue is here declined as a list of the most important topics and key points discussed during the 5th UIC Energy Efficiency Days conference (UIC EED 2014)⁸, showing where the European railway industry is going.

3.1.3.1 Latest European railway environmental movements

New methodologies of energy metering and billing

A correct measurement of the energy consumption represents the starting point for any energy efficiency program. By understanding where, and how, the energy is being used it will then be possible to target the measurement efforts, and then track the progress of efforts to manage these items.

⁸ The 5th UIC Energy Efficiency Days conference (UIC EED 2014) jointly organized by UIC, SNCB and Infrabel have been held in Antwerpen in Belgium, from 16 to 19 of June 2014

It is essential to keep track of the following pillars:

- Energy consumption for traction in diesel trains
- Energy consumption for traction in electric trains
- Non-traction energy (Buildings, stations and depots)

Energy Measurement in Diesel traction

In diesel traction, keeping the track of the consumption is relatively simple as it can be metered at the filling stations. Nevertheless some accuracy is needed in order to have a good evaluation of the whole fleet consumption, e.g.:

- Ensure all fuel points used by the fleet send data – not just the home depot
- Calibrate the fuel meters as part of the quality control system
- Automate the collection if possible – manual collection is a source of error

Modern diesels have engine data collected through the control system – cross check between fuelling records and the on-board flow meters and computers.

Wherever possible is a good habit to reconcile ‘top down’ estimates of energy use with the ‘bottom-up’ totals from individual trains. This may help track down areas of waste and uncontrolled loss if the numbers don’t add up. Tracking in this way for diesel fuel can also have an environmental benefit in detecting leakage, or even in revealing loss due to theft.

Energy measurement in Electric traction

In the case of electric traction, where electricity is supplied by an external grid, trains need to be equipped with an energy meter if the energy consumption has to be monitored. Meters can be retrofitted at relatively low cost on existing rolling stock. The cost is significantly lower if the meter is installed in new rolling stock.

Installing energy meters in trains, as evidenced by many projects of the UIC railway operators, allows several advantages:

- A very precise measurement of energy consumption, which can in turn ensure energy savings and provide the railway operators with precise indications on the effectiveness of the impact of energy reduction measures;
- A direct billing of train operators on a *per locomotive* basis so that they are only billed for the electricity they actually consume. This ensures that operators are encouraged to save energy, because they see the benefits reflected in their financial *bottom line*. Charging for electricity on a per kilometre or *lump sum* basis does not create this incentive;
- Energy meters can be equipped in order to communicate with Drivers Advice System and/or other technological facilities, boosting at the most the effectiveness of the energy management.

In the absence of meters it is still essential to have a good estimation of the energy consumption.

This can be possible by:

- using on-board juridical recorders (*black boxes*) to compute energy used from power settings;
- using infrastructure Manger's data and re-allocating consumption by algorithm adapted to the traffic flow of the railway operators (top-down approach).

In 2013 UIC sent a questionnaire to European Railway operators in order to understand:

- which energy measurement methods where in place;
- how many meters have been installed;
- how many meters will be installed by 2020.

The results of the questionnaire, summarised in table 1, shows that even if many companies are still estimating energy consumption via IM's data, the number of meters installed, will increase three-fold by 2020, as several operators are planning to install meters in their whole fleet.

In some countries such as Germany there is a legal obligation to install energy meters in trains. It is estimated that 25,000 energy meters will be installed in European trains by 2020.

Table 3 Energy measurement methods used by European railways

Railway	Energy measurement method	How many units installed	How many units will be installed before 2020	Total units installed in 2020	Energy metered fleet	Traction policy
CFR Marfa	Energy meters on board	300	-	300	100%	
DB *	Energy meters on board	-	-	-	-	
NSB	Energy meters on board	370	450	770	100%	Yes
PKP Cargo	Energy meters on board	15	-	15	-	
PKP Energetyka	Energy meters on board	940	-	940	-	
SNCF	Energy meters on board	10	3800	3810	-	
GRFFN CARGO	Estimates	-	-	-	-	
FS	Infrastructure manager's data	-	-	-	-	
HZ	Infrastructure manager's data	-	-	-	-	
HZPP	Infrastructure manager's data	-	-	-	-	
JR East	Infrastructure manager's data	-	-	-	-	
SNCB	Infrastructure Manager's Data	53	972	1025	5%	
IG	Infrastructure Manager's Data	-	-	-	-	
VR	Mix of the above	64	150	214	10%	Yes
NS	Mix of the above	-	-	-	-	
ÖBB	Mix of the above	170	910	1080	20%	
DSB	Mix of the above	219	-	219	100%	Yes
PKP Intercity	Mix of the above	17	-	17	6%	
PKP PLK	Mix of the above	-	-	-	-	
ProRail	Mix of the above	-	-	-	-	
SBW	Mix of the above	-	1800	1800	-	
MAV	Mix of the above	1600	1758	3358	100%	
CP	Mix of the above	419	34	453	85%	Yes
TOTAL		4127	9874	14001		

* German regulation makes it compulsory to have energy meters in trains

Source: UIC 2014

Basic requirements of meter have been fixed in 2011 by ERA. Then in 2012 Extra requirements have been published in harmonized CENELEC-standard (EN 50463). In 2014 a new TSI has become mandatory for all rolling stock, containing requirements for Data Collecting Service too. Since that date all new, renewed and upgraded traction units shall have an energy meter.

Energy Efficient Train Operation

The concept of Energy Efficient Train Operation comprehends the saving of energy through better planning and handling of train operations. Introducing energy efficiency and power management into timetabling as well as real-time operations enables timetable planners, dispatchers and drivers to manage their traffic in the most efficient manner whilst fully respecting the underlying mandatory conditions such as punctuality, capacity, etc.

The advantages connected to a good optimization of rail network traffic flows have been deeply investigated in the last years and nowadays is well known to railway operators that a good management of traffic flows can bring the following essential benefits for the railway: greater punctuality, increase network capacity and lower energy consumption.

Through the time, many railways have successfully improved their performance on these targets through a series of engineering and process improvements. Operational solutions such as ecodriving programmes, efficient timetabling and active traffic management have been included in most companies daily management.

Many railways have been developing their own specific technological solutions, like on board DAS to support the driver to run as smoother as possible. Currently the market of DAS offers varied solutions to

ROs, that can go from the very basic pre-computed advice to the driver up to traffic flow optimization by dynamic timetabling rescheduling.

The Swiss SBB company for example is implementing the so called ADL system, which via a connected DAS allows to detect on real time possible conflicts due to unplanned stop and to communicate to the driver an alternative optimized speed profile.

Figure 22 RCS – ADL From stand alone to connected DAS in Switzerland

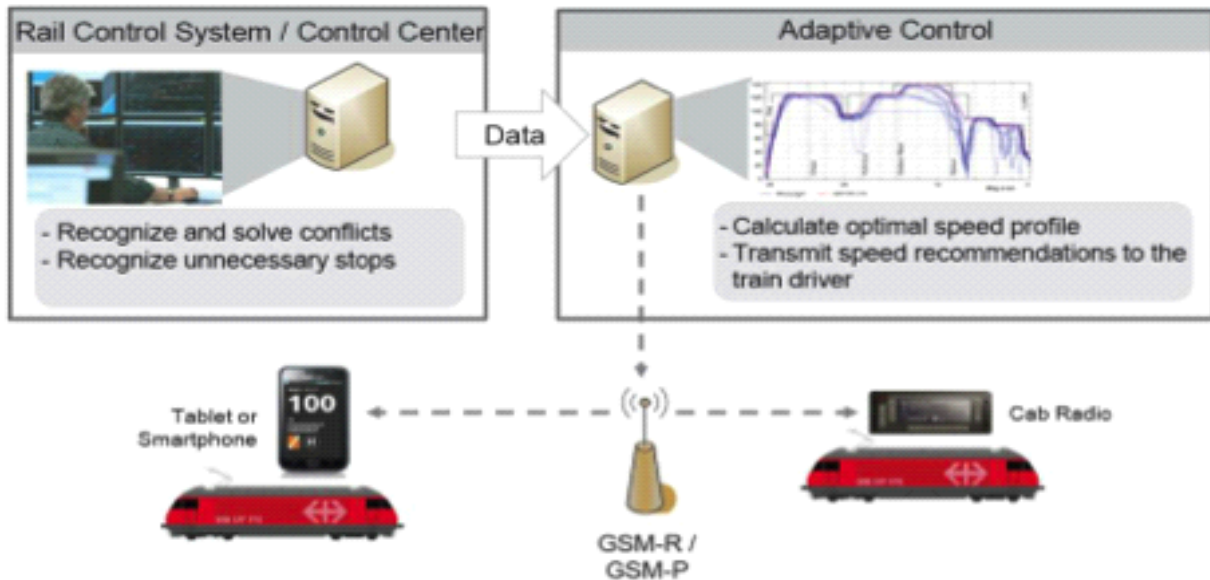

Thanks to this system SBB expects to increase the capacity of its network by 30% by 2030.

In June 2013 UIC organised a best practice exchange workshop on the issue "How a train driver can be supported to drive as energy efficient as possible?" in order to make the state of the art and identify the next challenges. The outcome of the workshop highlighted that to achieve the optimal train path, a track-to-train communication is necessary. This communication must become interoperable, enabling ground servers in different countries to communicate with different on-board equipment.

The recommendation can be summarised as follow:

- A communication between Traffic Management System and DAS is needed;
- Intelligence should be:
 - on board: responsibility of RO
 - on ground: responsibility of IM
- The aspects to be handled on board and on ground are the following:

	Board	Ground
S-DAS	Theoretic speed profile Train systems integration	-
C-DAS ↔ TMS	Real-time speed profile On time optimisation	Dynamic timetable Boundary conditions (route, speed limits) Conflict resolution

- Information to be exchanged between ground and on board DAS should be:

	From ground to train	From train to ground
Static data	Infrastructure (track locations, altitude profile, stations, ...) Permanent speed limits	Train characteristics
At start-up	Temporary speed restriction Timetable Not yet available static data Requested speed profile	Train composition: consists (including train length and weight)
Real time	Changes to planned track usage Changes to time table Changes to temporary speed restriction Changes in requested speed profile Low adhesion ares (when already known from other trains) Request to increase/decrease power offtake	Position from GPS Speed (GPS and odometry) Changes in actual train performance (acceleration and braking) Low adhesion areas (detected by train) Changes in train composition Announcing of recuperative braking or of voltage drop (results in request to increase/decrease power offtake for trains nearby) Consumption (over predefined period)

- The communication between TMS and DAS should be standardised and interoperable.

Efficient timetabling

The integration of energy efficiency criteria into the various planning processes from the very beginning is promising: the whole system may be optimized and significant energy saving are possible. Aspects with influence on energy consumption are for example the extension of travel times, optimization of track layout and harmonization of speed profiles. Also changed planning priorities of mixed traffic, the reduction of traffic demand peaks over day and the modular adjustment of train sizes according to demand allow a more efficient use of energy. However, given infrastructure, limited financial resources or the demand for shorter travel times handicap an energy efficient planning process.

Traffic Management System

More and more suppliers are delivering tools to improve the energy efficiency and punctuality of train traffic. New **Traffic Management Systems** should be able to detect possible conflicts (two trains arriving at the same time at the same crossing) and should be able to propose the optimal solution. This information should get communicated to the trains.

3.1.3.2 Cost-effective solutions to recuperate higher percentages of energy from braking

The use of regenerating braking functionality is one of the most important methods that allow energy savings in a railway transportation system.

There are three main technical issues:

- The possibility of other trains to pick up the regenerated energy for acceleration purposes due to the receptivity of the traction system that is mainly related to. The receptivity optimization for energy saving purposes can be achieved through better planning and handling of train operations depending on traffic density, headways and voltage drops on the traction supply line.
- Use of Reversible Traction Substations that provides the capability of feeding the train regenerative braking energy (up to 100%) to the external power distribution network, whilst maintaining the exchange of energy among trains on the traction supply line. The system receptivity is improved by feeding the excess of regenerative braking energy to the upstream network and this improvement is more effective in railway systems that are characterized by a low value of system receptivity. The most feasible and commonly-recognizable solutions that can be used on:

- DC Systems by reversible electric substations for DC traction networks;
- AC Traction systems with the same operating frequency of the external power supply network (50Hz);
- AC Traction systems operating at different frequency of the external power supply network (e.g. 15 kV 16.67Hz traction systems).
- Use of Energy storage system installed in either of two locations:
 - storage systems installed on board the vehicle realizing an immediate and direct electrical connection with the drive propulsion;
 - storage systems in substation or along the line as mechanical energy storage systems, Electric and Electrochemical energy storage systems (Batteries), Supercapacitors

For all technologies summarized above advantages and disadvantages, limitations on use, related time and cost implementation are well known.

To maximize the benefits of energy saving resulting from the energy recovery of braking while minimizing costs and implementation time, a systemic and holistic approach is necessary. The use of evaluation methodologies and tools such as those developed within the Merlin project become essential to support the complexity of the problem.

3.1.3.3 Procurement of energy efficient rolling stock

The UIC and the Association of the European Rail Industry (UNIFE) have jointly elaborated and published a document detailing technical recommendations on the “*Specification and verification of energy consumption for railway rolling stock*”, called TecRec 100_001 (UIC/UNIFE 2010). The TecRec 100_001 became a Technical Specification (Standard CENELEC CLC/TS 8650591) on November 2013. The standard serves as European Standard and it’s planned to become a European Norm (EN) in 2016.

The purpose of this Technical Specification is to provide a methodology to measure energy consumption for rolling stock so that measurements over time or for different types of rolling stock are comparable. This methodology enables measurements of improvements in energy efficiency of rolling stock, and it can further be used as a tool for railways to estimate energy efficiency performance as a consideration in the procurement process. Currently, about ten European railways are using CENELEC-CLC/TS 50591 in this latter capacity, as part of their procurement strategy.

The document defines infrastructure, operational, and environmental conditions in which to conduct a simulation or a real-life energy performance measurement of rolling stock. CENELEC-CLC/TS 50591 also provides a set of standard values for typical service profiles: suburban, regional, intercity, and high-speed passenger traffic.

Figure 15 shows a standard profile of CLC/TS 50591 used for freight mainline over a 300 km route. The profile indicates the linear distance from the departure station (A) to the arrival station (E) with stops in stations B, C, and D and two red signals (s1 and s2). The profile includes a mountain passage, as long-distance freight routes can include considerable variations in altitude.

Figure 23 CENELEC-CLC/TS 50591 standard profile for freight main line over a 300 km route. Top: altitude (m), bottom: speed (km/h)

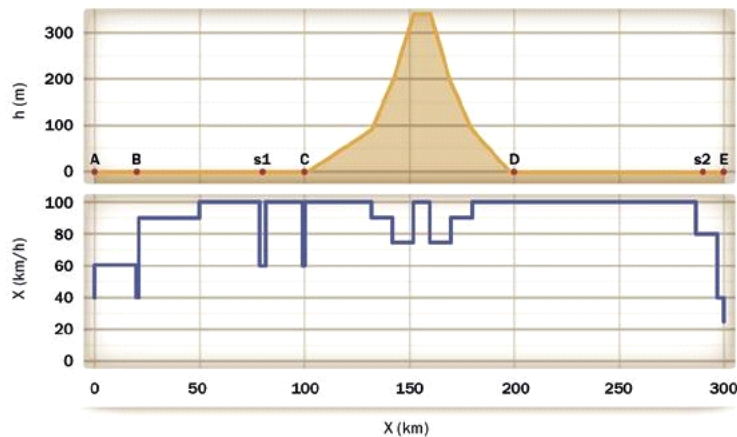

Source: UIC/UNIFE (2010)

It's necessary to make much better use of this guideline by disseminating knowledge and best practise examples among operators, manufacturers and relevant knowledge partners.

Lifecycle cost (LCC) analysis

The method of LCC analysis can also be a helpful instrument for introducing more energy-efficient railway rolling stock.

The basic idea of the LCC concept is that the costs of a product, for example a railway vehicle, are not only determined by the initial investment costs (purchasing price) but also by all other costs that occur during the product's lifetime, especially operational and maintenance costs. The LCC concept is especially relevant for railway rolling stock because of the usually long technical and economic lifetime (25-40 years or even longer).

As far as the operational costs are concerned, the assumptions about the energy consumption can be based on the analyses of direct indicators. With regard to LCC analysis, it is mainly kWh per train km or gross tkm that are relevant. In addition the definitions and assumptions about stand-by and comfort functions as well as operational measures should be consulted.

A practical problem is that today the suppliers are the main source for the necessary data. For technologies that are already in use, the individual operators should have the relevant data for their specific use cases. A Railway Company compiling awarding documents should be aware of this situation and challenge the bidders to commit themselves to specifications concerning LCC components. However, in case of new vehicles, especially when using new technologies, clear statements regarding life cycle costs are harder to obtain.

3.1.3.4 Optimization of load factor in passenger service

As mentioned in the chapter "Challenge and limitation" load factor is one of the main indicator to measure the efficiency of a transport service. The idea is simple: getting the most from the energy used, a full train is the best efficient way to move passenger or goods.

Load factor improving has been indicated as the next most important energy efficiency measure to be put in place in the 15 coming years by most of the EU railway companies that responded to a questionnaire sent by UIC in the framework of the technical study *Energy Efficiency Drivers*.

As a matter of fact, in Europe *the average occupancy rate of trains is still quite low compared to other transport modes*, in particular for the passenger sector. A major part of rail passenger traffic takes place in the morning and evening's peak. Outside of these rush hours trains run almost empty. This unbalanced

demand leads to an inefficient use of rolling stock so also an inefficient use of energy. An optimization of load factor represents a real challenge for the EU rail sector in the coming period.

Being load factor defined as the ratio between passenger km and seats km, in order to improve it is possible to act either increasing the number of passenger/goods (numerator) or either adapting the size of train to the number of passenger/good transported (denominator).

The load factor can be determined with different degrees of accuracy as follows:

- Total year average for all trains of a railway operator
- Average for a specific train service
- Max value between 2 stops for a certain train
- Real time value for a certain train
- Real time value for each coach in a train

Different methodologies or facilities for load factor calculation are possible:

- Periodic counting / estimation by train personal
- Automatic camera detection on doors
- Automatic detection of weight of each seat
- Automatic detection of weight of coach

A top recommendation concerns collecting load factor data: an accurate registration and follow up of occupancy figures per service type and per hours is essential to the aim of optimizing the passenger flows. Currently many European railways only obtains occupancy information via manual counting on board of train and ticket sales, therefore in the area of travel information there is still a lot to be gained.

The Dutch railway company NS is working on an innovative automatic passenger counting project that communicates in real time the occupation information at compartment level allowing the customers in finding a free seat. The occupation rate is automatically monitored enabling the RO to better match train composition with customer demand. Even more, the project will dramatically improve the NS knowledge of the occupancy of its trains, allowing to better customize the offer on the demand.

3.1.3.5 Further implementation of diesel traction energy efficiency potentialities

Even if Europe's railways are among the most electrified of the world, diesel traction especially in some countries and especially for certain types of traffic has still a very important role.

The CleanERD project demonstrates the feasibility and reliability of railway rolling stock powered with "EU stage IIIB" diesel engines. Anyway according to the future development of European rail Diesel fleet until 2020 a late entry of EU stage IIIB engine and locos locomotives is expected. On a declining number of locos as global trend, a significant number of new locos EU IIIA is expected to take place in 2020.

The renewal of the European diesel fleet will take place through an increasing number of DMUs of which a significant part will be provided by IIIA & IIIB engines.

The main energy efficiency potentials of diesel traction (rolling stock & operation) are summarised below:

- Ecodriving & DAS (Saving Potentials of 5 - 20 %, Higher Potentials for traffic flow management);
- Parked Train Management (From low tech to system solutions, 3-10% energy savings);
- Reuse of Braking Energy (Different Storage Options, 3-10% energy savings);
- Smart Energy Management (Software changes to systemic approaches, up to 10% savings);
- Automatic Engine Shutdown (dependent on train type, route, timetable , 5 – 8% energy saving);
- Fuel Injection & Combustion Improvements (4% energy saving);
- Hybrids loco (Reduced fuel consumption up to 20 %).

3.1.3.6 Implementation of non-traction energy consumption managing systems

Fixed facilities, infrastructure and wayside related subsystem auxiliary system

Non-traction energy includes energy consumption mainly in railway stations, maintenance workshops, buildings and infrastructures. In particular actual and future stations are being designed with the aim to become central urban nodes in modern cities, larger and more comfortable to passengers and customers, yet also very energy demanding. Buildings and workshops use energy for lighting, heating and cooling. Infrastructure needs energy for signalling, crossings, platform lights, GSM-R and point heating. It is generally acknowledged this is an area with a significant saving potential which is largely untapped.

Accordingly to UIC research project on this topic, the figure below illustrates “time for implementation” versus “energy efficiency potential” for different types of relevant measures. It is a generic picture applicable to all the fields of activity for non-traction energy efficiency in the railways. In the lower left corner are those measures which need little investment and short implementation times but also limited saving potential e.g. awareness campaigns and improved operations. Efficient equipment and optimised control require higher investments but also yield considerably higher energy savings.

Figure 24 Recommendations for activity fields

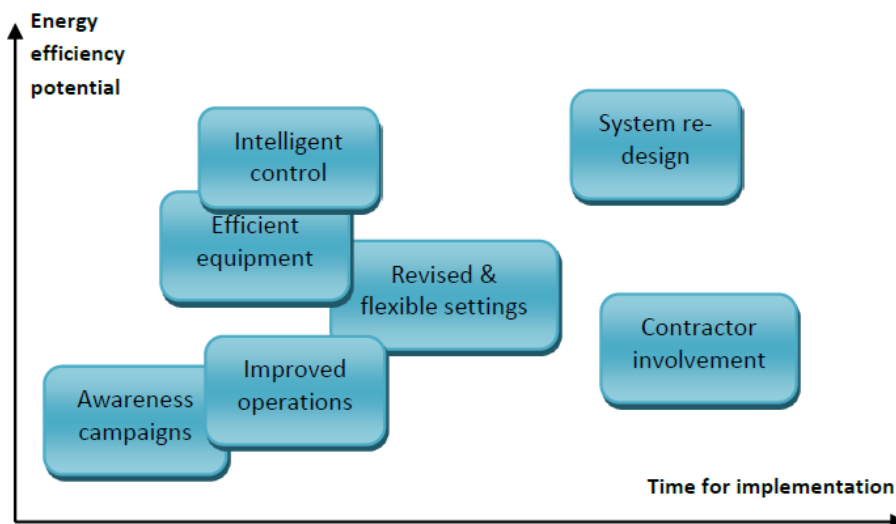

Source: IZT, Macroplan 2012

Rolling stock auxiliary system

Not all the energy consumed by a train goes towards traction: part of the energy is needed to operate systems used by passengers and goods carried on the train. For example, energy is needed for heating, ventilation and air conditioning (HVAC), as well as for lighting, power plugs, information screens and the opening and closing of doors. These are called “hotel loads”. Estimates on the amount of energy needed for hotel loads range from 10-15% and in some cases up to nearly half of the total train energy consumption (UIC, 2015).

Figure 25 Hotel loads in Swiss Railways (SBB/CFF/FSS) ICN train sets

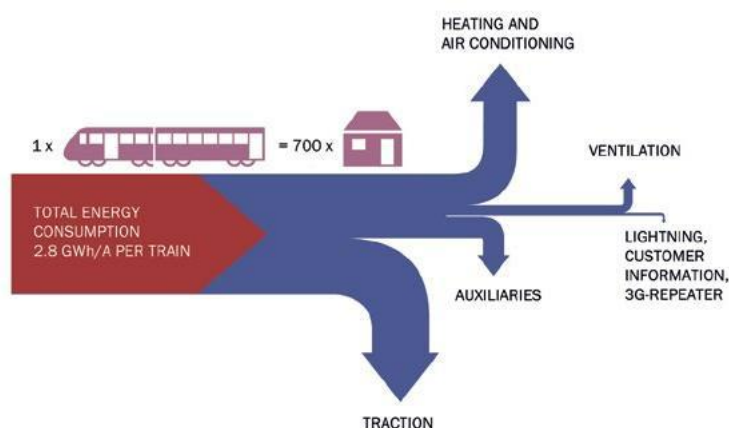

Source: SBB (2015)

The approaches to improving the energy efficiency of train hotel loads overlap in fact to a large extent with those that have been adopted to improve the energy consumption in buildings. For instance, insulation can reduce the energy consumption of HVAC system, and LED lighting can replace standard lighting to reduce energy use. Innovative technologies such as heat pumps, air cooling, and natural ventilation can also be implemented on trains.

3.1.3.7 Recommendations a company level

Global consumption map and analysis

The first step to enhance a strategic environmental program a company level is to obtain a global energy consumption map. An energy consumption map is a comprehensive and graphic way of representing the energy flows in the whole railway power supply systems. These maps provide a good overview of the energy, allowing a better understanding of what the energy has been used for (running the trains, operating stations or workshops, etc.) and enhancing the decision making processes. Consumption maps are a powerful tool to identify when and where measures oriented to increase energy efficiency can be implemented.

To prepare the energy consumption maps, a general representation of the power supply infrastructure should be included and infrastructure manager should be involved in this action, providing data of network topologies and energy consumption of the network.

Process, Power, People

The issue of energy efficiency for railways is highly dependent on working processes that take place within companies. The human factor is crucial. In order to have a successful energy efficiency programme a series of preparatory steps are needed:

Policy and a Plan

A successful Policy must include all significant aspects of energy use, and show:

- Commitment from top management
- Clear and credible goals
- Consistency with other company objectives

Behind the Policy must be a detailed plan listing specific actions to take the company forward. The Policy must be reviewed regularly to make sure it remains relevant to the needs and objectives of the company.

Clear Targets and Objectives

Finding the answer to the classical questions "where are we" and "where do we want to go", also by starting with an energy audit if necessary. Overall company targets must then be broken into *bite sized chunks* and given as objectives to individual managers and their local staff teams.

These must be:

- Achievable – and with realistic timescales
- Fair – don't expect one department to do all the work!
- Measurable
- Backed up by practical support (this may be capital investment, training programmes or new measurement systems)

Roles and Responsibilities

The Energy Policy and the supporting plan must spell out who is responsible for what, and what particular targets they each have to achieve. At the top one Director should have accountability for energy consumption – and the objectives of his colleagues and the other managers and staff must support the target that has been set.

Competence and Communication

Once people with roles and responsibilities for energy have been identified, the next step is to ensure they are competent and well informed.

A training should be given if necessary in order to be sure that people involved have an understanding of:

- The cost of energy
- The environmental problems caused by energy wastage
- How, in simple scientific terms, energy is used for different activities
- How their actions can improve matters – and how to do things differently
- Measurements and Records

Without measurement systems and good record keeping no programme can be successful. Clear measurement of energy consumption for traction and non-traction data should be kept and updated regularly. This will be the base for understanding if and how the energy efficiency measures in place are effective and re-adjust it if necessary in a "plan-do-review" cycle.

Figure 26 Plan – Do – Check – Act Cycle

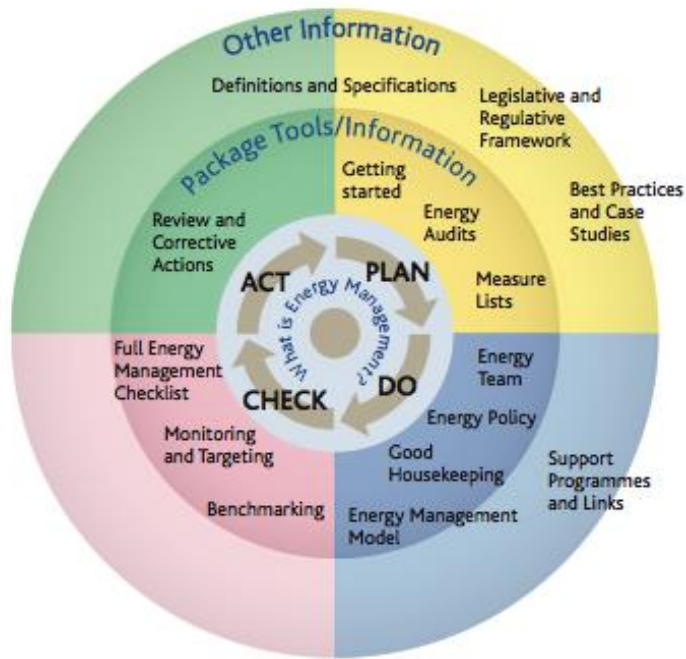

Source: UIC

3.2 CO₂ Reduction

As reported in the previous chapter, the issue of reducing CO₂ emissions and energy efficiency are strongly interconnected. The reduction in energy consumption results in lower CO₂ emissions. Nevertheless, if the main objective is the reduction of CO₂, there may be differences in terms of strategic approach as well as in terms of reduction driver. There are measures that reduce CO₂ emissions that are not associated with improved energy efficiency. This chapter focuses on these aspects.

3.2.1 Current situation

The rail sector was responsible for 1.5% of the total CO₂ transport sector emissions in 2012, equal to the 0.46% of the total European CO₂ emissions. As already described in the energy efficiency paragraph, the rail contribution to the total amount of emissions has to be considered in the light of the rail transport activity that was 7.6% for passengers and 10.6% for goods in 2012.

Figure 27 European share of CO₂ emissions from fuel combustion by sector, 2012

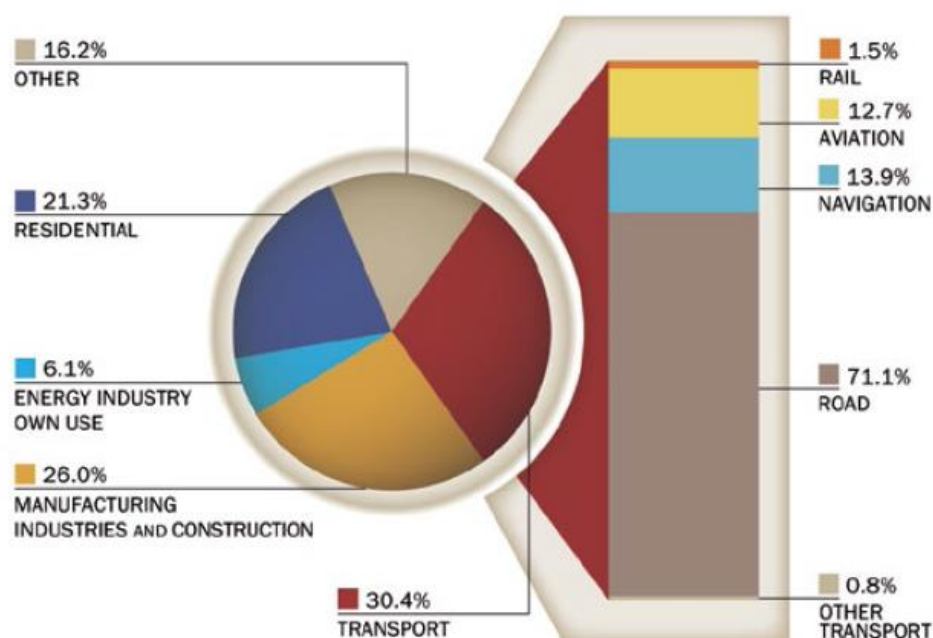

Source: UIC IEA Handbook 2015

The rail CO₂ share of transport sector has more than halved since 1990, and in absolute values was equal to 18.4 million tonnes in 2013 considering the national electricity production mix and 15.2 million tonnes using the production mix declared by the electricity providers, respectively -42% and -52% considering the 1990 values⁹.

⁹ The issue of CO₂ emissions calculation using the national energy mix (location based - physical approach) or the energy mix declared by railways and electricity suppliers (market based – virtual approach) will be analyzed in detail later in this chapter.

Figure 28 European railway sector total CO₂ emissions, 2013 (Million tonnes)

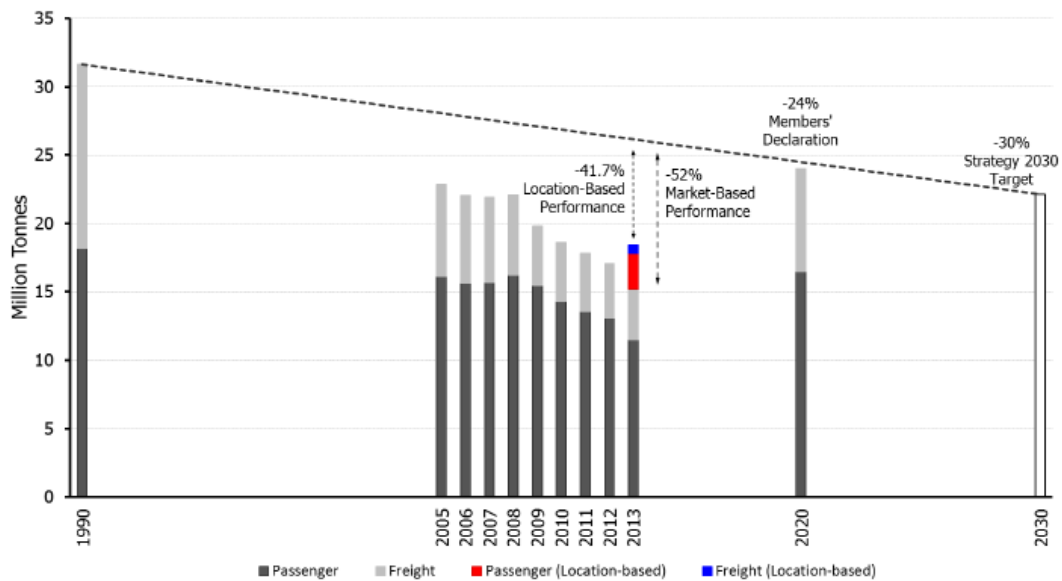

Source: UIC 1990-2030 Environment Strategy Reporting System – 2015 Report

About specific emissions by European railways in the passenger sector (figure below), considering the electricity mix purchased by railway operators, in the time frame 1990-2013 the specific CO₂ emissions from the passenger sector have been reduced by 42%.

The performance is in line with the target, being the value of CO₂ emission per pkm value results to be well below the expected “linear” value for 2013 (-31%).

Considering the physical approach (national electricity mix), in the time frame 1990-2013 the specific CO₂ emissions from the passenger sector have been reduced by 28.7% and the performance is not in line with the target as the actual location-based real value exceeds by 2.3% the expected “linear” value for 2013.

Figure 29 Trend of specific CO₂ emissions for passenger (upper graph) and freight services (graph below), also related to the 1990 values and the 2030 Strategy Target

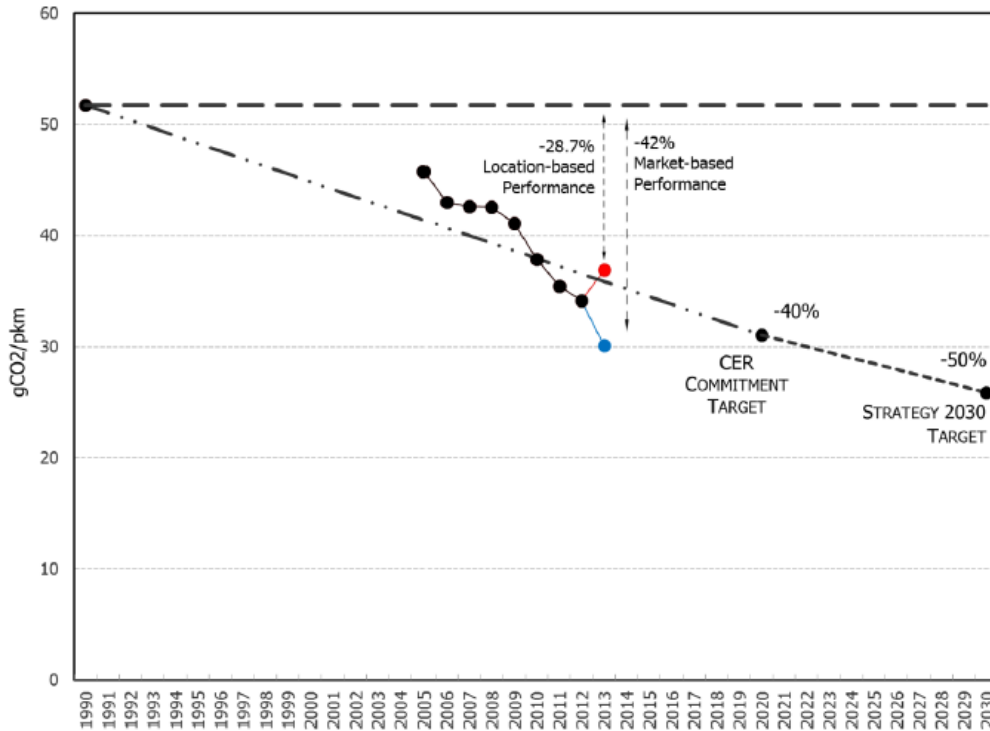

Source: UIC 1990-2030 Environment Strategy Reporting System – 2015 Report

From freight sector (figure below), the specific CO₂ emissions have been reduced by 46% from 1990 to 2013 and by 36.9% considering the physical approach. Both of them correspond to a higher reduction than the expected “linear” value for 2013 (31%).

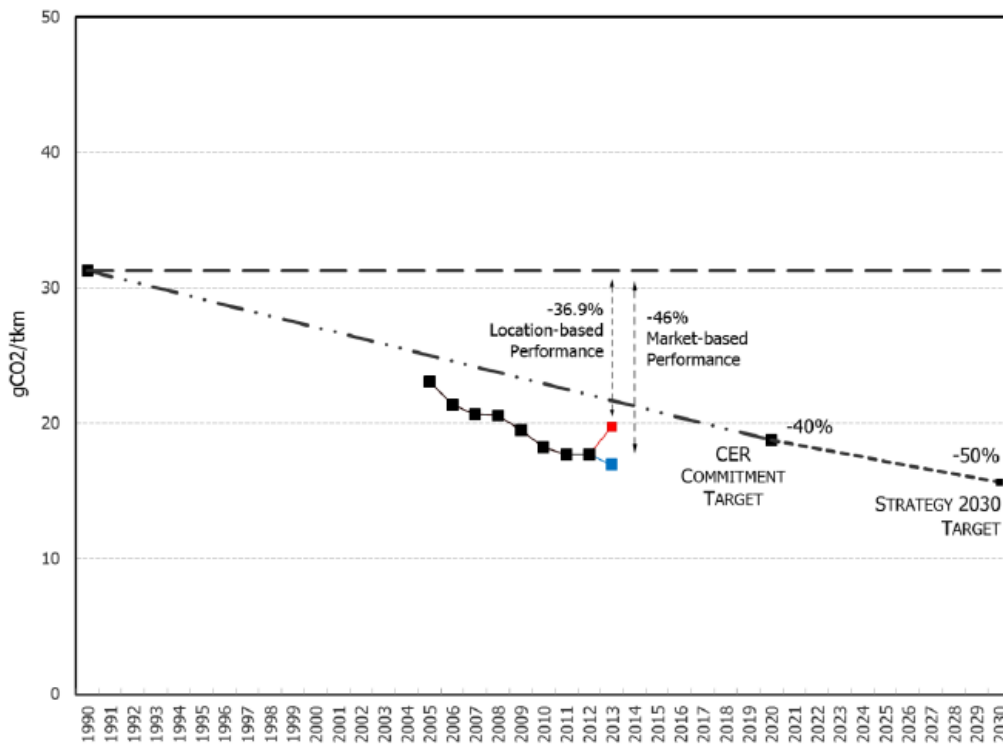

Source: UIC 1990-2030 Environment Strategy Reporting System – 2015 Report

The specific CO₂ emissions trends in the figures above refer to the European average and it is important to note that there are many differences between single railway companies, in terms of values and in terms of contribution to the decrease. The following figure shows the specific energy consumption, passenger and freight, for some of the main European companies; as seen in this graph, there are strong differences in terms of g/pkm of CO₂ that in large part can be explained by the energy mix of the country in which the railways operates.

In fact the emission factors used to calculate the CO₂ emissions for DB (Germany), OBB (Austria) and SNCB (Belgium) are respectively 554 g/kWh, 153 g/kWh and 185 g/kWh. The national electricity mix issue is extensively analysed in the next section of this chapter.

Figure 30 Specific CO₂ emissions for electric traction – total passengers (g/pkm Location based) benchmark, 2013 (DB, OBB, SNCB)

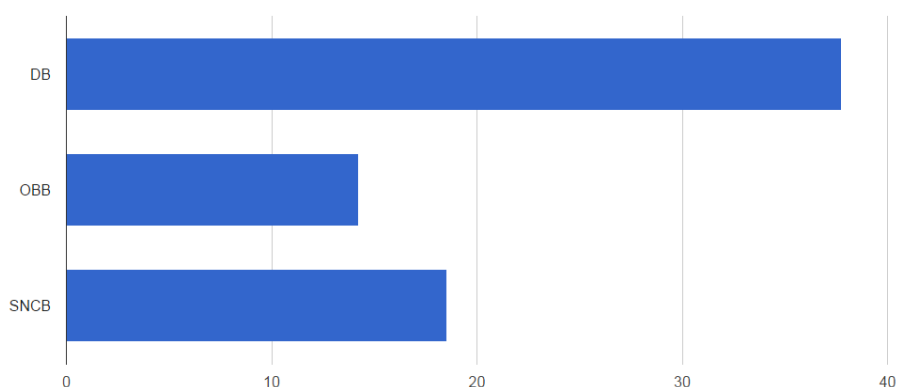

Source: UIC CO₂-data.org (confidential, for UIC members only).

According the study about energy and emission reduction drivers¹⁰, the DB contribution to the CO₂ specific emissions reduction is the largest as well as for the energy efficiency (see figure below). In 2012, the participation of DB to the specific CO₂ emissions reduction was more than one third of the total amount in the passenger sector, while it was about 50% for the freight service. In terms of absolute values DB has more than tripled its contribution from -1.74 to -6.38 g/pkm in the period 2005-2012, while in the freight service it improved its performance from -4.67 to -6.85 g/tkm. It should be also pointed out the share of ATOC (25%) and PKP (15%) to the CO₂ specific emissions reduction respectively in the passenger and freight services, as shown in the figure below.

¹⁰ Already quoted on Energy Efficiency chapter

Figure 31 The reduction of specific CO₂ emissions for passenger (g/pkm, left) and freight (g/tkm, right) with the contribution attributed to each European railway company

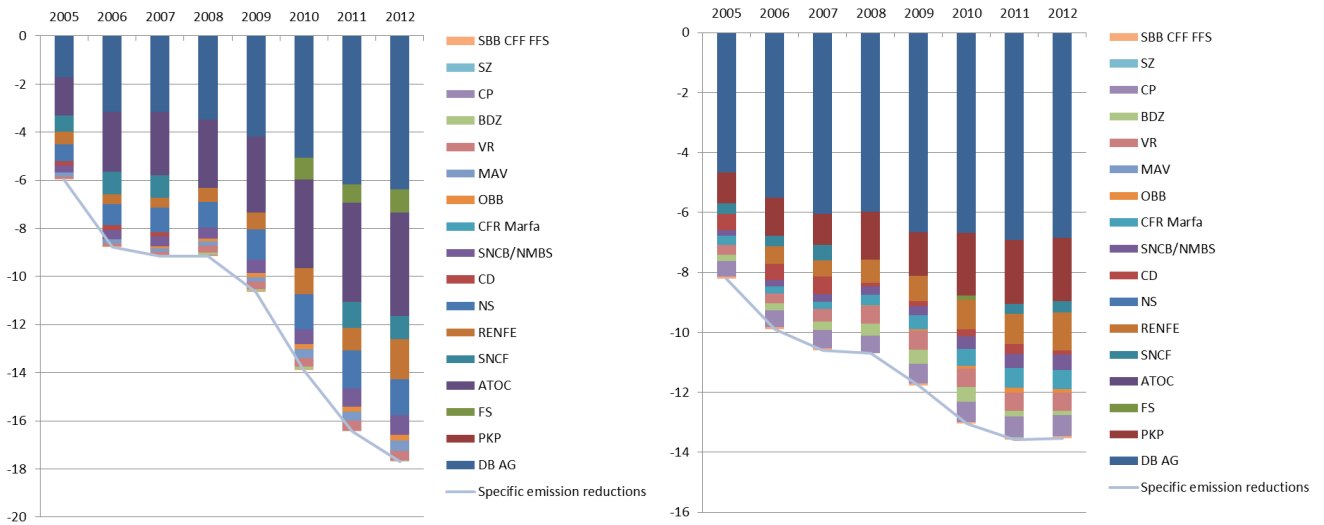

Source: UIC/CER, Energy and emission reduction drivers for European railways, 2014

According to the same survey of 2014, as reported in the figure below, the CO₂ specific emissions reduction is mainly due to the energy efficiency both for passenger and freight services. It is relevant also the contribution of electrification and the improvement of national electricity mix that helps to reduce the carbonic intensity of the kWh in Europe.

Figure 32 Main results of UIC survey

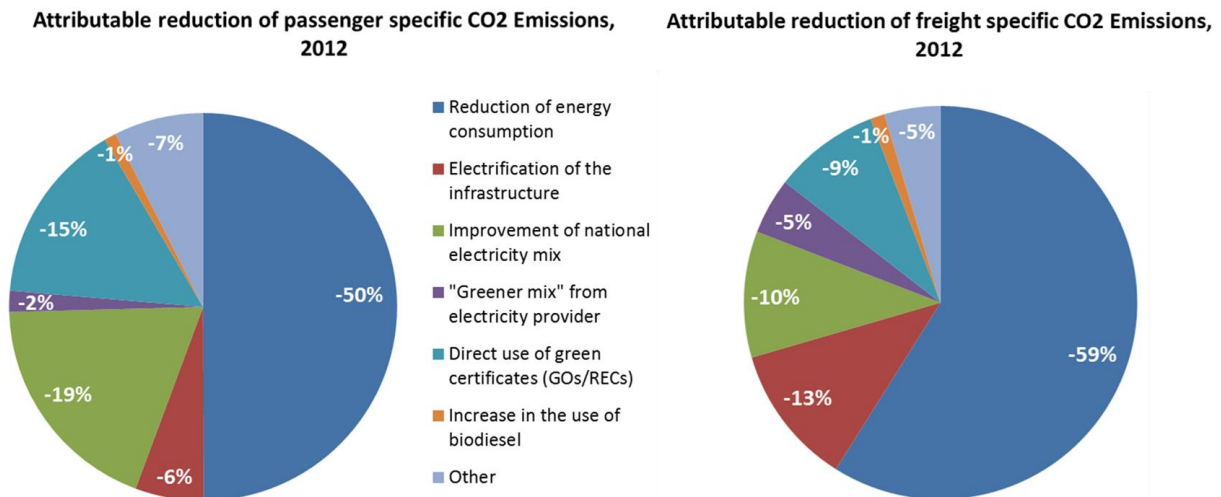

Source: UIC/CER, Energy and emission reduction drivers for European railways, 2014

In particular, the electrification of traction is a major driver in the reduction of CO₂ emissions by railway undertakings: by having trains run on electric power, it is possible to reduce the environmental impact of traction by acting on the emission factor of electricity (which can potentially go all the way down to zero if the electricity is entirely produced with renewable sources).

As can be seen in the figure below, for DB in passenger service and for SNCB/NMBS in freight service, the reduction of specific emissions goes hand-to-hand with the increase in electrification (calculated by dividing the train-km of electric traction divided by total train-km).

Figure 33 Carbon intensity (g/pkm) compared to electrification rate (%)

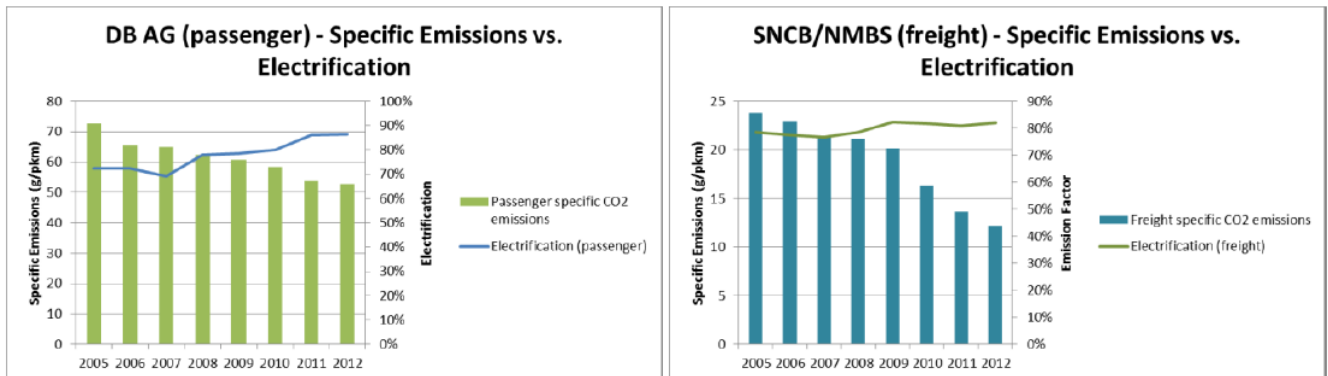

As mentioned, the electrification of railways can be matched by the reduction of the electric emission factor in order to improve the railways' specific emissions. In the graphs below, it is possible to see a direct relationship between the emission factors declared by railways and the reduction in their CO₂ emissions.

Figure 34 Carbon intensity (g/pkm) compared to the emissions factor

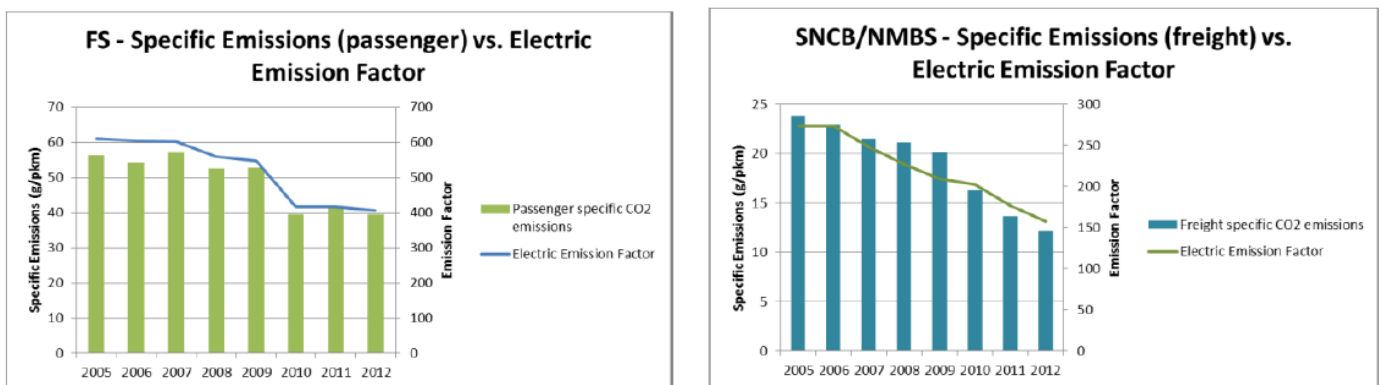

3.2.2 Challenges and limitations

3.2.2.1 The EU railway sector CO₂ emission reduction voluntary strategy

As seen in the first part of the Report¹¹, the EU had made clear the political imperative of setting medium and longer term targets for the reduction of CO₂ emissions. For the rail sector this policy and legal framework is an unavoidable challenge, full of positive consequences. On one hand the railways, in terms of CO₂ emissions, are in a condition of competitive advantage in relation to other means of transport, on the other it's mandatory to consolidate this advantage for the future.

In this context, on 2008, CER members agreed on a CO₂ reduction target for the whole European railway sector: 30% specific emissions reduction in 2020 compared to 1990 baseline year. By 2030 the European railways will reduce their specific average CO₂ emissions from train operation by 50% compared to base year 1990. In addition, by 2030 the European railways will not exceed the total CO₂ emission level from train operation in absolute terms even with projected traffic growth compared to base year 1990.

In order to monitor the environmental performance of the European Railway Sector towards the four targets set by the UIC/CER Sustainable Mobility Strategy 2030 and beyond, the UIC Environmental Strategy Reporting System (ESRS) has been created as a comprehensive instrument which allows the overall

¹¹ The first part of the Report is dedicated to European environmental policies and regulations.

procedure of construction of indicators, data collection, analysis, reporting and data sharing to be regulated in a clear and transparent structure.

The ESRS is an evolution of the UIC Energy & CO₂ Database, which was started in 2005 to collect and analyse the railway sector's energy and CO₂ performance values, and has been updated on an annual basis. The database takes into account figures regarding both passenger and freight service, and has been used to show the picture of full energy/CO₂ performance data from the year 1990.

Further aims of the ESRS are the following:

- Collect, analyse and verify the consistency of key environmental performance data from all European member railway operators;
- Provide correct information about the environmental performance of railways, internally and externally, to all stakeholders such as institutions, customers, media etc.;
- Understand the trend of the sector for comprehension, improvement and benchmarking purposes;
- Provide data to the on-line environmental calculators *Ecopassenger* and *EcoTransIT World*

The ESRS system is composed of six main elements, as shown in the figure below:

Figure 35 ESRS Structure

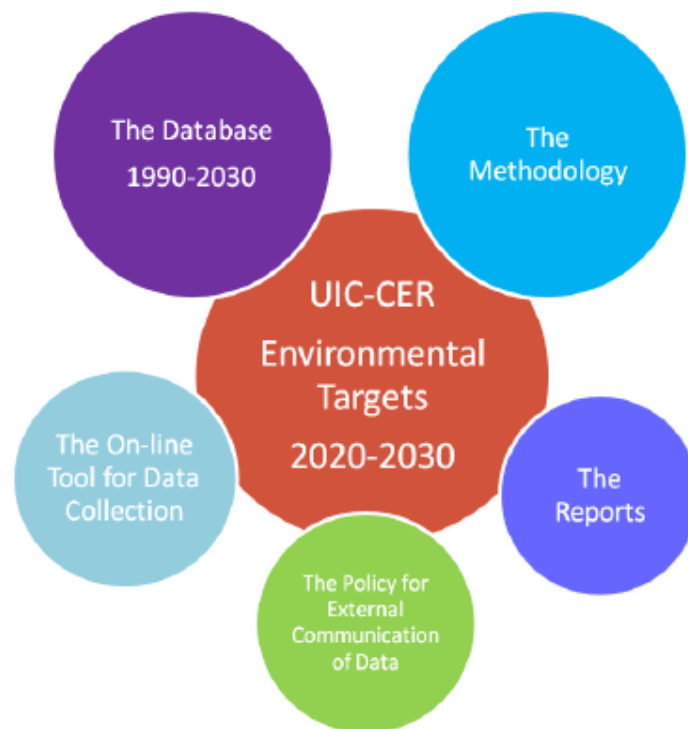

Source: UIC ESRS

- The Environmental Targets are central to the whole system, as they are the final objective. The targets can be modified or updated by the General Assemblies of UIC and CER, following a proposal of the UIC Environment, Energy and Sustainability (EES) Platform and the CER Transport, Environment & Energy Strategy Group.
- The Environmental Performance Database contains the data collected annually from each railway operator: energy consumption data, production data and emissions data (CO₂, PM10 and NO_x). The database accounts now data for 39 railway companies in 29 countries, timeline 2005 - 2013. For energy and CO₂ emission also the value 1990 is available. It represents a unique source of direct data from railway operators. It is part of the UIC Official statistics and since 2012 it is the main

source of the International Energy Agency for data on Energy consumption and CO₂ emission of the rail sector.

- The Methodology is the guideline to collect, account and report the environmental Key Performance Indicators (KPI) of UIC railway members. These rules are a vital compendium to the environmental performance database as all data has to be consistent in order to provide comparable and scientifically-based results.
- The On-line Tool for Data Collection (www.CO2-data.org) allows the collection of data from all railways in a safe and consistent way, and assists the railway members in calculating some key indicators from the data they provide. Even more it works as a platform where, once the data are validated, the railway members are able to access data from other railway companies, analyse the trends of the sector for comprehension, improvement, benchmarking and other purposes. Here below an example of the output of the on line tool.
- The Periodical Reports present yearly the progress of UIC/CER in meeting their environmental targets set for 2020, 2030 and 2050.
- The Policy for External Communication of Data regulates the response to requests of data from external entities, setting guidelines for data sharing with UIC/CER members and non- members.

By establishing its own voluntary strategy, the rail sector aim to reduce the likelihood of having targets imposed on it, and to demonstrate that it's a responsible and forward thinking low-carbon mode of transport, whose role should be enhanced as part of the wider move to decarbonise transport.

The strategy also can provide a framework that allows single companies in the rail sector to make long-term plans, using it as a guide, and ensuring that the low-carbon advantage of rail is retained.

At the same time, other transport modes has already demonstrated their keenness to act to reduce GHG emissions: in 2009, the International Road Transport Union (IRU) has adopted a voluntary commitment to reduce specific CO₂ emissions by 30% by 2030 using a 2007 baseline, while the International Air Transport Association (IATA) adopted a target of reducing CO₂ emissions by 50% by 2050 compared to 2005.

In this framework the new voluntary strategy adopted by the EU rail sector is an essential challenge in order to gain support at political level and increase rail market share.

It can be useful highlight that the absolute CO₂ emission reduction target can limit the expansion of the market share of railways in the future.

3.2.2.2 Support the development of renewable energies and biofuels

As reported in the table below, the emission factor varies greatly from one European country to another. The national production mix represents the share by fuel of the electricity produced in a given country and fed in the network. Energy mix relative to the domestic production of electricity strongly influences the CO₂ emission reduction results obtained by the companies in specific and in absolute terms.

Table 4 Emission factor based on national electricity production mix in some European countries, 2013 (gCO₂/kWh)

UK	513	Netherlands	547
Bulgaria	543	Austria	154
Czech Republic	549	Poland	920
Romania	486	Spain	287
Portugal	338	Switzerland	6
Germany	555	Belgium	186
Italy	406	France	64
Hungary	307	Slovenia	339
Finland	260		

Source: UIC ESRS Database

The excellent performance of the railway sector reported in the first paragraph of this chapter is in part due to specific policies implemented by the railway sector players, but it is also in part the consequence of the increase of renewable sources in the production of electricity in Europe.

The share of renewable energy of European electricity production has increased by 10% in the period 2000-2012, reaching the share of 24% of the total amount. In correspondence with an increase in use of renewable energy and a small increase in use of gas (+ 2%), the use of fossil products (coal and oil) and nuclear have decreased respectively by -7% and -3%.

Figure 36 EU28 electricity production mix evolution, 1990-2012

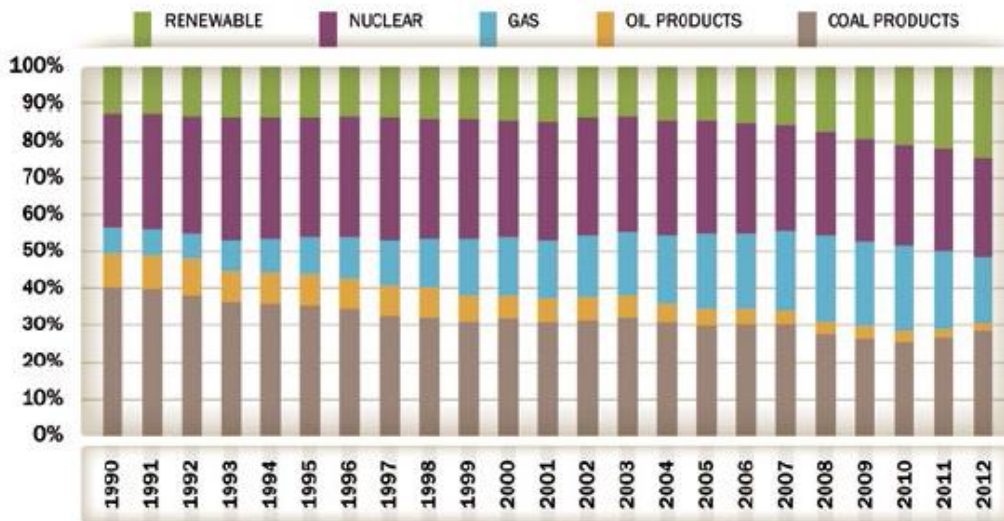

Source: UIC IEA Handbook 2015

The greening of the electricity mix has benefited the railway sector more than any other transport mode, as rail is the mode that uses electric traction the most. Increasing the share of renewables in electricity generation mix represents an indisputable advantage for the railways.

Figure 37 Renewables in transport and railways in EU27 (%)

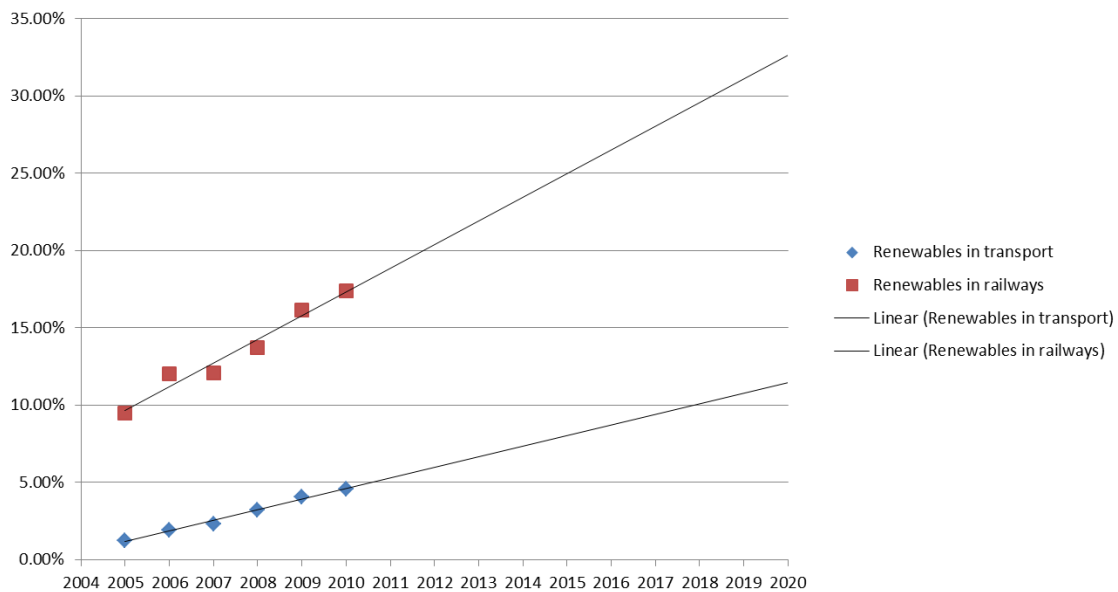

Source: Elaboration by SUSDEF based on IEA (2012b) and UIC (2012b)

Railway sector can support these sources of energy in different forms. This support is strategic and synergic at the same time.

Actually, most of European railway companies are using

- *Renewable energy certificate (GO/REC)¹² procurement*: Railway companies procuring credits from the voluntary market can claim, after certificates have been used (cancelled), that they have purchased a quantity of renewable energy corresponding to the number of GO/RECs.
- *Green power procurement*: An energy supplier offers to the railway company a guarantee that its power has been produced using a certain percentage of renewable energy. Normally the supplier simply buys certificates as GO/RECs but in some cases the supplier's own assets may be feeding power into the grid. In either case, the recipient of the electricity can claim that they are purchasing renewable energy while the burden of assuring its origin is on the supplier.

It is important to understand that the function of RECs and GOs goes beyond enabling railway companies to increase the share of renewables in their electricity mix for carbon accounting or as an instrument of green marketing, allowing railway customers to purchase certified electricity to express environmental values.

RECs and GOs railways use can support renewable energies:

- indirectly, operating on the demand side;
- directly, supporting renewable energy producers with the influx of new capital.

The following European railway companies already buy RECs or GO: VR, SJ, Greencargo, NSB, DSB, PKP, OBB, NS, DB and RENFE and some of them are purchasing 100% of electricity from renewable sources. The electricity consumed by these 10 railway companies in 2012 corresponds to 18.6 TWh, meaning the 42% of the total electricity consumed by the European railway sector.

This way to greening railway electricity has a great limitation. A number of NGOs and technical bodies have questioned the acceptability of some green electricity procurement, calculated as CO₂ savings by railway sector. Several NGOs argues that the green certificates system is purely a "mind game" potentially generating contradictory messages, without creating "additionality" (i.e. new renewable energy installations). They see as "wishful thinking" the possibility of extra revenue coming from certificate sales being invested in the installation of plants for renewable energy production. The extra revenue from certificate sales does not turn automatically into new investments on renewable sources, or just in a very small percentage: no additional renewable electricity is generated, or very little.

All these arguments can communicate an ambiguous and potentially counter-productive message for the environmental image of the railway sector.

Biofuels use is another examples of synergies between railway and clean energy sector: biofuels are instrumental in helping EU countries meet their 10% renewables target in transport while represent a fundamental tool to reduce railway CO₂ emissions.

The figure below shows the large increase of biofuels consumption between the European railways, grown by 500% since 2004.

¹² In 2001 the Renewable Electricity Certificates System (RECS) was introduced. Almost at the same time the initial Renewables Directive 2001/77/EC brought about the introduction of the GO. The Association of Issuing Bodies (AIB) set up the European Energy Certificate System (the EECs System) to be able to handle both the REC certificate and the GO.

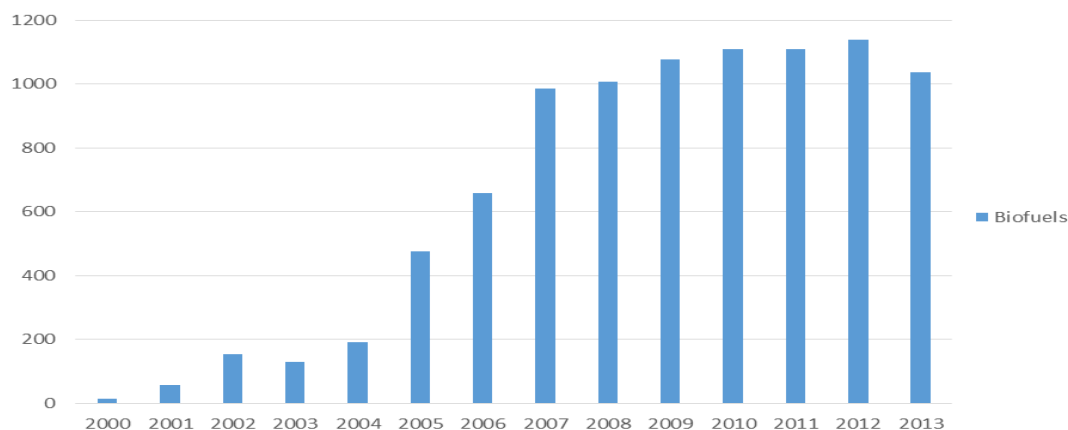
Figure 38 Railway final consumption of biofuel, 2000-2013 (TJ)

Source: Elaboration by SUSDEF

Although the Renewable Energy Directive (2009/30/CE) sets out biofuels sustainability criteria for all biofuels produced or consumed in the EU, some environmental NGO argue that this measure can attempt counterproductive results. If left unchanged, EU legislation promoting biofuels for transport can lead to higher, not lower greenhouse gas (GHG) emissions when indirect land use change (ILUC) caused by biofuel production are taken into account.

3.2.3 Recommendation

The ultimate goal of a strategy to reduce CO₂ emissions for a company operating in the railway market is not only ethical but also economic. The efforts undertaken and the results obtained in this field must be reported to three different stakeholders: customers, public opinion and the media, institutions and governments. The recommendations focus on this aspect.

3.2.3.1 "The best possible way": choosing the most eco-friendly transport option

The International Union of Railways (UIC) has developed two user-friendly internet tools, Ecopassenger and EcoTransit, for comparison of the carbon footprint, energy consumption and pollutant emissions performance of different transport modes.

The two tools are very simple to use and allows to check in short and clear terms the impacts of customers travel choices of different modes of transport.

In spite of his user friendly interface, the methodology behind the calculations are sound scientific, focusing on a life cycle approach to the energy involved, and approved by the European Environment Agency.

The actual version of EcoPassenger website contains the possibility to implement a short widget in other websites. This functionality allows UIC pages and members to include a basic form of the tool to perform calculations for their clients.

Figure 39 Back of the Trenitalia's ticket (Italian railways)

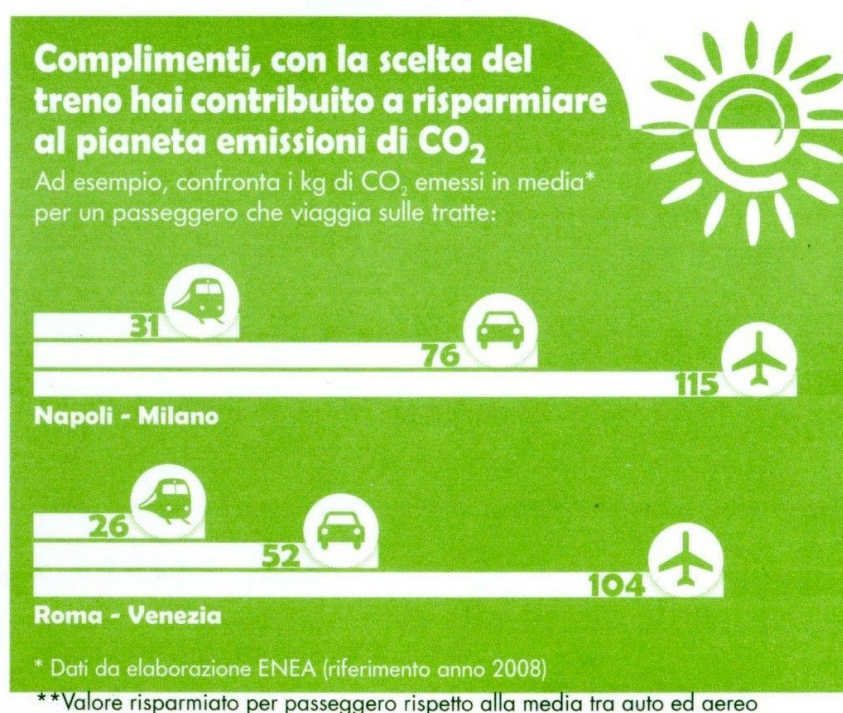

CO₂ emissions per trip can also be displayed in other ways. In the picture above you can see the back of the ticket of the Italian railways. This is a simple way to create awareness among customers on the environmental impact of their travel choices.

The EcoTransIT tool is mainly directed to the logistics companies. To ensure highly-customised questions definition of the nature of cargo, detailed features of the different types of means of transport, load factor and empty trip factor are provided.

3.2.3.2 How to deal with the risk of “green-washing”

As seen before, railways need to increase and support the use of renewable energy and at the same time keep their environmental credibility. But a greening strategy must be clear, honest and widely accepted in order to not be accused of bad communication and cause severe brand damage.

On this point the European experience on Green Certificates use in railway sector carbon accounting can provide useful recommendations.

As seen before, a number of NGOs and technical bodies have questioned the acceptability of some green electricity procurement, calculated as CO₂ savings by railway sector. In order to improve the methodology of calculation related to the procurement of renewable electricity by the railway companies, following the UIC Zero-Carbon Project undertaken by UIC in 2013-2014, the UIC ESRS has adopted the so called “dual reporting approach” as recommended by the GHG Protocol Scope 2 Guidance.

The CO₂ reporting must be conducted always using two different approach:

- physical approach: only physical flows of electricity are taken into account;
- virtual approach: the electricity fluxes taken into account are the ones associated with the contractual instruments, including certificates and guarantees of origins, independently by the physical flux.

The physical approach (grid based) is considered in principle the most appropriate for the UIC evaluation and monitoring of the UIC-CER CO₂ reduction targets, as this approach provides to harmonize under a common methodology the different calculation methods used by each company in each country throughout Europe.

On the other hand, many European railway companies are investing (technically, economically and financially) in acquiring always higher quantities of green electricity for their train traction. The use of Guarantees of Origin is one of the tools to do this legally and properly, and to make the carbon disclosure technically feasible. This practice is also an effective way of supporting renewable energy producers with the influx of new capital.

Deutsche Bahn is one of the largest European purchaser of GO and RECs, declaring a 100% green power for its train on the 1st April 2013. Through new products as the Bahn-Card business, Deutsche Bahn guarantees all the corporate customers with the use of 100% green power on all business travel in long-distance trains. Other interesting service from DB is the tool Eco-plus that allows to move goods entirely carbon-free. This smart marketing strategy could not exist without green certificates use, as GO and REC.

This strategy, to be more and more credible and appreciated by the stakeholders, must be accompanied, as indeed is the case of DB, by other measure to increase renewable energies as

- *Direct investment*: the railway company directly invests in on-site renewable energy assets and consumes the energy generated. The assets are sometimes connected to the local grid for the sale of surplus power and for the purchase of any deficit. In order for the company to claim that the energy consumed is renewable, GO/RECs must be withdrawn by the company rather than sold. If applicable, surplus power and the associated GO/RECs may both be sold.
- *Power purchase agreement (PPA)*: The railway company purchases electricity from a specific renewable energy project and the associated GO/RECs are produced. These are long-term bilateral agreements, which contain clear commercial terms for the transfer of electricity and the associated GO/RECs between the two parties. The assets are either hosted remotely (the renewable energy is then transported through the grid) or located at the site of the company (e.g., photovoltaic systems on an office roof).

3.2.3.3 To build a consensus on an environmental strategy

As already mentioned there are several reasons to believe that the measures reducing the CO₂ emissions of the railways should be well communicated outside, particularly in regard to political institutions. As mentioned in the chapter dedicated to energy efficiency, the boundaries of the action of a railway company are extremely porous. Some factors are direct competence of rail company, whereas others are outside its sphere of influence. These are not marginal issues but central aspects such as, for example, the receipt of essential funding from the government to improve infrastructure and renew the rolling stock. Then there is the decisive aspect of technical standards which must be operational on a country level. In addition, as highlighted in the case of energy efficiency, from a systemic point of view, the role of the railways in terms of sustainability does not end in the reduction of their impacts but also in the ability to represent a credible alternative modal compared to other less sustainable means of transport. The modal shift is a tool both to promote the railway sector and the green transition of the transport sector as a whole.

All call for building consensus around the railway sector and the role it can play as part of climate policy.

Consensus building around the railway sector is delicate and can take different forms. UIC for example, first in behalf of the railway sector and recently of the world, has assumed some voluntary commitments in terms of reducing its CO₂ emissions. These initiatives, quoted in the challenge paragraph, are intended to create a broad international sharing on the role that railway sector can play in the achievement of general purposes, as fight climate change. This role allows the railway sector to require attention and consideration by government policies, calling for political and financial support.

It is useful to cite an example of this consensus-building policy. The effort made by UIC in setting up an accurate framework for the collection of energy use and CO₂ data from rail operators on a yearly base, led to the signature of an agreement between UIC and the International Energy Agency, for the annual publication of a common handbook on energy consumption and CO₂ emissions of the world railway sector. The publication is now at its fourth edition.

This cooperation for a more robust and solid set of data represented a real milestone for the rail sector environmental performance communication. In fact, it allowed not only to have a "certification" of the good performance of railways in an international scientific context, but also to introduce "direct" data from railways in the international official statistics.

The database represents in fact the unique source of direct data from railways on energy and CO₂ emission, while other sources of data presented in official publication are just estimations based on several assumptions. In this last case, the data presented is out of the control of the rail sector itself. The creation of a flux of direct data of the rail sector from UIC towards official scientific body as the IEA allowed the rail sector not only to have a good performance "blessed" by an internationally recognized scientific body but also to have an important control on the data circulating.

3.3 NOISE

3.3.1 Current situation

3.3.1.1 Noise exposure of rail traffic in Europe

The European Environment Agency report “Noise in Europe 2014” provides an overview and assessment of environmental noise. The report states that about 125 million people in Europe are affected by road traffic noise levels greater than 55 dB Lden, which are considered potentially dangerous.

Railways are the second most dominant source of environmental noise in Europe, with nearly 7 million people exposed to levels above 55 dB Lden in 2012 considering people exposed both inside and outside urban areas.

Estimation — based on calculated figures complementing current reported data to estimate the overall number of people exposed — increases this figure up to nearly 14 million people, doubling the current reported data, with more than 4 million people estimated to be exposed to major railways transport outside urban areas and 9.5 million people estimated to be exposed to railways transport noise inside urban areas.

Figure 40 Number of people exposed to noise in Europe > 55 dB Lden in EEA member countries (2012): reported and estimated

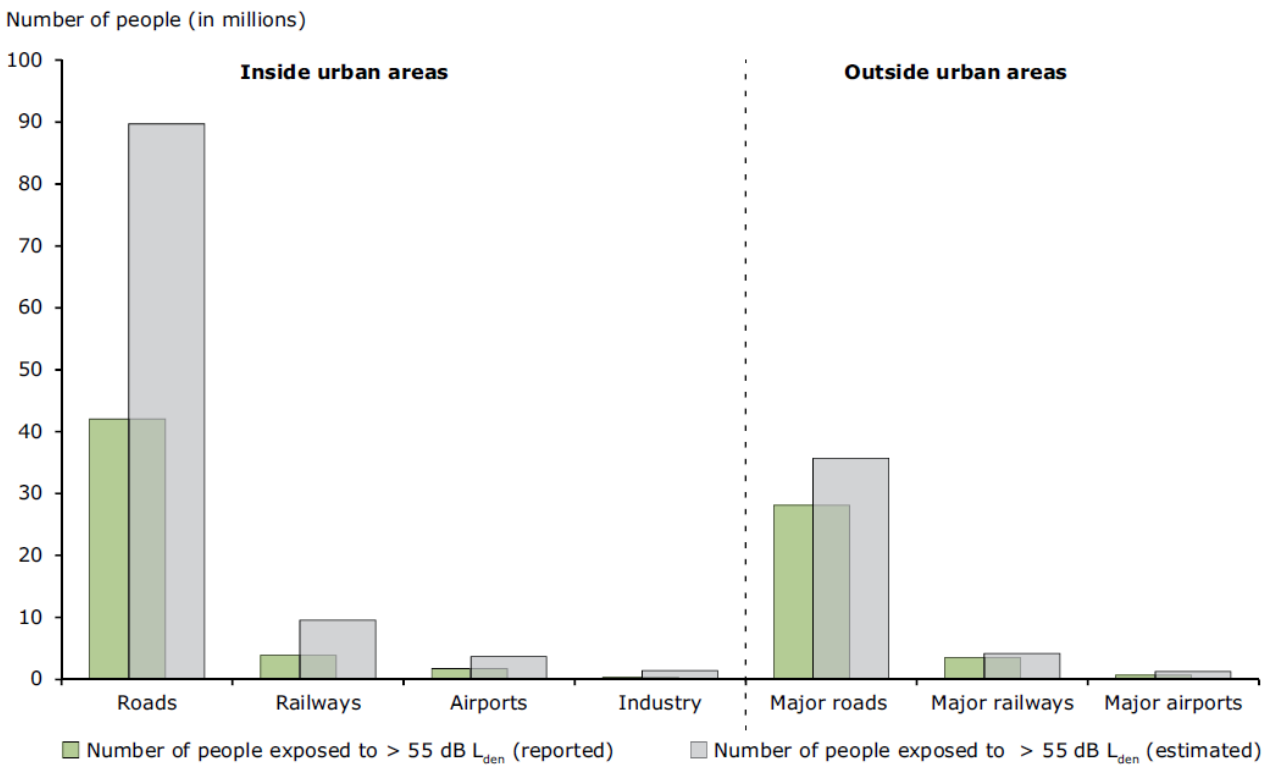

Source: EEA 2014

The exposure of the European population to railway noise is much less than the exposure to road traffic noise as is indicated by the figure above, which is partially due to the fact that the number of railway lines is smaller than the number of roads and rail noise is generally perceived as less annoying. The distinction between road and railway is increased by the fact that the annoyance due to a certain level of railway noise is lower than the annoyance experienced by the same level of road traffic noise.

3.3.1.2 Railway Noise Sources

The most important noise source is rolling noise, which affects all kinds of train. Rolling noise is generally higher from poorly maintained rail vehicles, and from trains running on poorly maintained infrastructure.

Rolling noise consists of noise radiated by the track and noise radiated by the wheel. The rolling noise is the result of a separate mechanical process in 4 stages:

- excitation due to irregularities in the wheel/rail contact
- vibrational response of the wheel, rail and sleeper construction due to these forces
- transmission of the vibration into radiated sound
- propagation of the sound into the environment

Noise, caused by the steel wheel rolling on the steel rail is always present. It increases with speed and is dependent on wheel and rail roughness levels. Cast iron tread braked wheels have a higher surface roughness than disc braked wheels or those braked using composite block brakes. Consequently they are noisier.

Power equipment noise (Engine noise) comes from a variety of sources including the engine, fans, exhaust outlets and traction motors. This generally has little or no dependency on train speed but can be significant in situations where full power is required, especially at low speed when rolling noise will be low. Power equipment noise is potentially a more serious problem for diesel traction compared to electric traction.

This type of noise source is important more and more for parked trains (Stationary noise). The noise emitted from parking sites stems only partially from moving trains (arriving, leaving and shunting) and else is largely emitted by technical aggregates on rolling stock such as engines, fans, pumps and compressors. The parking areas are often located in urban areas, so that the noise emission of parking vehicles leads to complaints from local residents. These complaints can lead to restrictions on railway operators, who often need to carry out essential preparation work (e.g. cleaning) and maintenance of rolling stock at night.

As train speed increases noise from the flow of air (Aerodynamic noise) over the train surface can become significant in the area of pantographs, coach end connections, and bogie areas etc. where changes in cross section affect that air flow.

Figure 41 Sound pressure level as a function of train speed

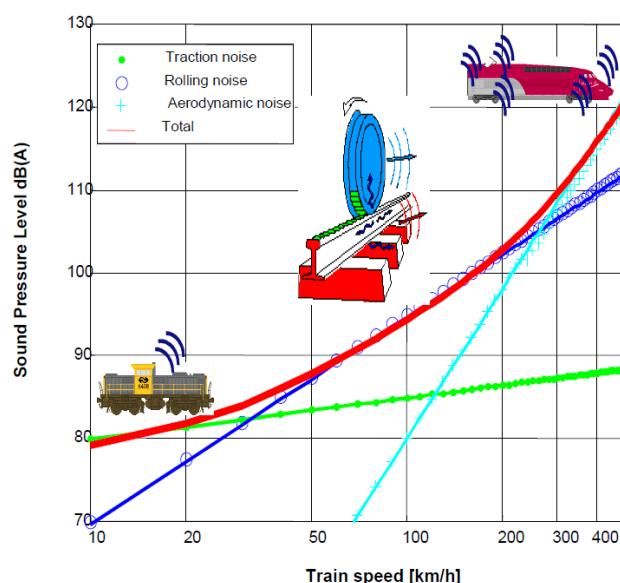

Source: UIC 2008

Aerodynamic noise becomes significant at high speed (over 200 km/h) reaching a noise level similar to rolling noise. For electric trains, pantograph noise is also significant at high speed. Pantographs and the leading bogie are the two main sources of aerodynamic noise.

In specific situations other noise sources can dominate. Examples are curve squeal, brake screech, broadband braking noise, elevated structure noise.

Railway noise is largely a problem of freight trains and is a particularly severe problem during the night. This can be explained by:

- freight trains running more frequent at night when the capacity of the line is not needed for the regular person traffic. In the night, the sensitivity to noise is 10 times larger as during the day as is expressed in the penalty of 10 dB applied in the Lden calculation.
- conventional freight train that produces 5 to 10 times more sound energy than a passenger train with the same speed and axle configuration

The current settings noise regulation implies the following types of noise: stand-still noise, starting noise, pass-by noise, noise in the drivers cabin.

For freight stock only pass-by noise and stand still noise is defined, for passenger coaches also the noise in the drivers cabin (if applicable) is considerable and for this reason is regulated, while for electric and diesel locomotives and electric and diesel multiple units additionally a starting noise limit is set.

3.3.1.3 The UIC-CER railway noise strategy path

In the early nineties, in a joint effort under the leadership of UIC and CER, the European railway sector has invested heavily in research on railway noise. It was found that the cast iron brake cause high levels of surface roughness of the wheel, determining the rolling noise. For many years the only low noise brake blocks available were so-called K-blocks that have a different friction performance compared to cast iron brake. However, to maintain the braking performance, it is necessary to make expensive changes to the entire braking system. The brake replacement and modification to the braking system has been too expensive for most of the railway company and this has prevented use on a large scale installation of the K-blocks on the existing fleet.

In STAIRRS project, launched in the late '90s, various noise control options to reduce noise in terms of costs/benefits were compared. It was found that the most effective and most convenient solution was represented by the replacement of cast iron blocks of existing wagons fleet. The solution less efficient in terms of cost/benefit view instead is represented from raising noise barriers. The conclusions of STAIRRS paved the way for the Railway Noise Action Plan, agreed by UIC, UIP and CER. The action plan has focused efforts on the following objectives:

- Increase the railways transport output,
- Reduce the environmental impact, in particular noise.

More specific, the Action Plan included:

- Cost neutral equipping and retrofitting of wagons with cast-iron brake blocks to composite brake blocks (K/LL),
- Gradual introduction of “Low Noise Technology”.

For the Action Plan, attention has focused on reducing noise from rail freight. The concrete goal would be to retrofit the main part of the European wagon fleet with low-noise brake blocks. In order to maintain a level playing field, financial support from public authorities, preferably by the European Union, was required to offset the costs of compliance. This should include both investment for the retrofitting and any increases in operating costs due to increased wear of the wheels and the brake block prices.

In their search for cost-effective noise mitigation railways have launched a program to develop a new type of the brake block, the LL-block, which could reach a frictional performance similar to cast iron blocks, but

with smoother wheel surface. This would allow simple replacement with cast iron blocks (without major modifications to the braking system) and therefore low cost retrofitting.

The UIC EuropeTrain project successfully concluded in 2013 following which two LL-blocks have been approved for use. In addition to the cost of LL-blocks and costs workshop adaptation, experience shows higher operating costs due to wheel wear and more frequent inspection and maintenance.

3.3.1.4 EU rail noise abatement strategy

The European Community, as well as providing a framework on the noise issue, has developed a strategy for action by evaluating different approaches, separately and integrated with each other, such as:

- Subsidies for retrofitting (incentives approach)
- Noise-differentiated track access charges (NDTAC approach)
- Application of TSI-Noise limits to all wagons (TSI Noise approach)
- Introduction of a noise limit along the TEN-T railway Network (TEN-T approach)
- Introduction of noise limits in relation to density of population (Density approach)
- Track management in relation to noise (Maintenance approach)
- Introduction of a general maximum transport-related cumulative noise exposure (Environmental health approach).

Developing a regulation scheme for a staged process towards low-noise rolling stock is the heart of a rail noise abatement strategy. The main pillars on which to base this mitigation strategy are the TSI Noise and the NDTAC scheme.

The Noise TSI (Regulation 1304 of 26 November 2014 known as TSI NOI) sets out noise limits for new rail vehicles in addition to renewed or upgraded wagons. These include stationary, starting and pass-by noise for all types of rolling stock, as well as noise limits for the level in the driver's cab. Provided that it complies with these requirements, it is not possible for a Member State to refuse access to a rail vehicle on the basis of its noise performance. Under the railway interoperability directive (Directive 2008/57/EC), a Technical Specification for Interoperability on Noise (TSI Noise) was adopted in 2005. Amended several times afterwards - current version –Regulation 1304/2014 – in force since 1/1/2015. It sets out specific noise limit values applicable to rolling stock introduced after entry into force of the TSI Noise

In a system of noise-differentiated track access charges (NDTAC), the fee that the operator pays to the infrastructure manager for running a train on the track differs depending on the noise emission: lower track access charges are offered as an incentive to retrofit wagons and operate 'silent' trains. It is assumed that these savings will be passed on by the operator to the wagon keeper and that this will incentivize the retrofitting of existing wagons. Commission Implementing Regulation (EU) 2015/429 sets out the modalities for charging for the cost of noise effects (NDTAC)

In the short- to medium term the current EU approach is:

- application of harmonised noise-charging principles (NDTAC);
- financial support (EC + national);
- noise-related standards of railway infrastructure (acoustic rail grinding + track maintenance);
- revision of TSI Noise - gradual application of TSI Noise limit values to all wagons
- Gradual application of TSI Noise limit values to all wagons

From a temporal point of view, this approach will be applied gradually, with a transitional period where supporting mechanisms are deployed, a first stage the application of TSI Noise limit values are mandatory only for international freight wagons (certain opt outs possible) and a second stage where the applicability of TSI Noise is extended to all existing wagons.

3.3.2 Challenges and limitations

The interest of the European rail sector is undoubtedly to meet the needs of health and wellbeing of populations who live in Europe close to the railway lines. It is not just an ethical or legal standard that become gradually more and more demanding: for the railways is vital to maintain the primacy of more sustainable transport modes.

From this supremacy in the field of sustainability comes down the opportunity, identified at EU level, to shift traffic from road to rail in the context of the greenhouse gas emission reduction strategies and reducing energy consumption.

At the same time it is not possible to promote the modal shift from road to rail without increasing rail capacity. Increased rail capacity is a necessary condition to allow an increase in rail traffic and involves an expansion of the rail infrastructure (lines, stations, depots, maneuver areas, freight terminals ...).

These interventions not only need large funds but also the consensus of the population living along the tracks. Railway noise is one of the main reasons for the protest of local communities against the railways. These protests relate to existing lines but especially those yet to be realized in the future. Large public demonstrations have been experienced in case of the new high speed trains such as between Paris and Marseille, Amsterdam-Brussels, London-Manchester, the freight corridor through Rhine Valley and the Betuwe, the rail freight transit through the alpine countries Austria and Switzerland and several other cases.

To ensure the health and welfare of the inhabitants of the negative impact of the railway noise is necessary to take measures which are very expensive.

New vehicles can be fitted with composite tread brake blocks (K-blocks), but these are not suitable for retrofitting. EU estimate in 2013 that there are still about 370,000 freight wagons with cast iron brakes which are worth being retrofitted in Europe, and finding a cost-effective composite brake block replacement (LL-blocks) for retrofitting is a priority for many railway operators. The EU 2013 estimate for retrofitting the 370,000 freight wagons is between 2.2 and 4.2 billion Euros, but the impact of LL-blocks on wheel set maintenance costs is yet to be established.

Existing measures are not sufficient – business as usual will result in no significant progress until 2030. Freight wagons not in line with TSI-Noise limits are the most important source of rail noise and to retrofit them is the most efficient way to reduce noise (up to 10 dB = ½ less in terms of human perception). Add to this that 50% of rail freight transport is international.

How to do that without affecting rail and trigger a modal shift on the contrary, from rail to road? The railway sector to improve their fleets and their infrastructure should make an effort from the economic point of view it would have an impact on the competitiveness of railway companies, benefiting therefore competing modes of transport which, from the point of view of noise, are much more harmful.

As noted in previous sections, the rail system is extremely complex in itself. Rolling noise is the most important type of noise associated with the railway system. This occurs as an effect of the interaction between vehicle and track. For this reason a whole system approach involving all of the relevant stakeholders (operators, vehicle owners and infrastructure managers) is often required in order to effectively reduce noise emissions.

Rail transport has a complex and evolving structure with many different stakeholders, these include:

- the operating companies (running the trains), mostly indicated as railway undertakings (RU);
- the vehicle owners (often leasing companies);
- the infrastructure managers, responsible for planning, construction and maintenance of the tracks (including signaling and power provisions).

With respect to noise, many more stakeholders are involved:

- The European Commission, particularly DG MOVE, has defined clear objectives for a modal shift from road to environmental friendly modes such as rail, while reducing the number of European residents being exposed to excessive noise. In setting political goals, the Commission is supported by institutions like the World Health Organisation (WHO) and the European Environment Agency (EEA);
- The European Rail Agency (ERA), on behalf of the Commission, sets noise emission limits for railway vehicles being approved for the European market;
- National governments commonly set limits for railway noise reception and, on the basis of environmental impact assessments, approve plans for expansion or significant renewal of the infrastructure;
- Local authorities supply permits for local activities, and may check compliance with the legal limits.

The complexity increases in Europe in the framework of rules that promote competition and the creation of a single railway market. In Europe the possibility for Member States to intervene with the direct funding to railway companies to renovate or retrofit their fleets is limited because of the standard 50 % co-funding limit that is specified in the EU state aid rules.

This possibility is also affected in practice by the poor economic situation and the fiscal consolidation process in all member states.

On the other hand the raising of technical standards on the existing fleet must take place on a consistent basis throughout the continent in order to ensure full interoperability of the European network, without creating any sort of limitation.

The perception of the impact of noise problem due to the amount of population affected by the impact of railway noise, is rather uniform across the European continent. Railway noise is considered an emergency in some EU member states such as Germany, Austria and other countries such as Switzerland, which although not part of the EU, is crossed by a major rail freight corridors, the hall No. 1 Genoa-Rotterdam. The risk of unilateral national measures (speed/night restrictions) leading to barriers to railway interoperability and internal market is high. A piecemeal approach creates another risk of a modal shift from rail to road.

Figure 42 Percentage of population exposed to railway noise, Lden, in 270 urban areas, EEA member countries (2012)

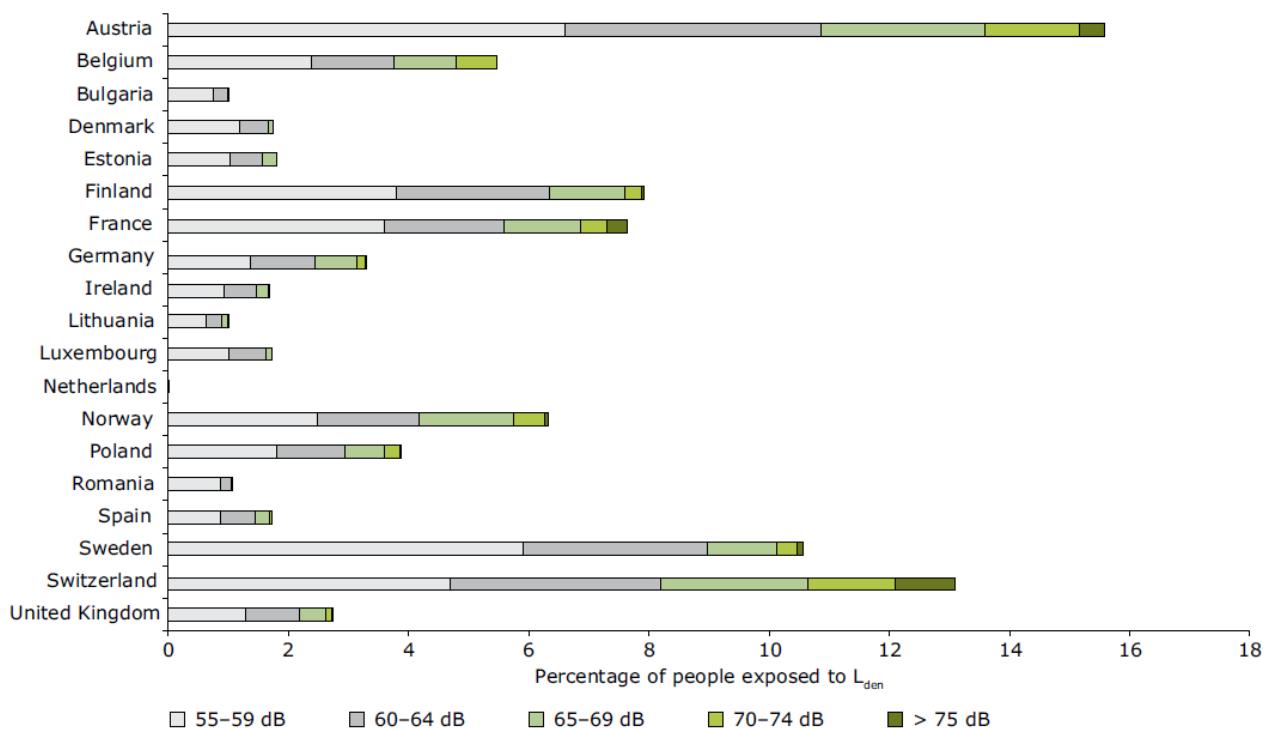

Source: EEA

The national initiatives with respect to incentives for retrofitting appear to be effective. However they can only have a limited effect as long as they apply only to

- the wagons registered in the particular country
- the wagons that circulate on the particular national network

In ten years there potentially will be 400,000 wagons circulating on the Trans European Network. Although the Swiss fleet and the German DB Cargo fleet, together with the private wagons registered in Germany, represent a significant part of that European fleet, it is of great importance that wagons registered in countries other than the three mentioned and used in international traffic are also retrofitted or replaced by silent stock. The challenge is that this applies to freight fleets based in countries which do not have a national legislative incentive for retrofitting. Further it is not currently expected that these countries will make budgets available for retrofitting in a similar way to the German and Swiss governments. Therefore, in order to realize the full benefit offered by retrofitting, more financial support is required for the many wagons based in countries other than Germany and Switzerland.

Notably, the Swiss Federal Government has announced a unilateral ban of wagons that do not meet the TSI NOI limits, due to be implemented from 2020. Although Switzerland is not a EU Member State it has many bilateral agreements with the EU. The German government is presently considering other options for discouraging the operation of wagons that do not comply with the TSI NOI limit values.

In the Staff Working Document, the EC expresses serious concern about these initiatives, fearing that they could be a risk for the open market, the principles of inter-operability and thus cause disruptions to the cross-border rail services. This in turn could lead to a reverse modal shift from rail to road.

The EC proposals in the Staff Working Document therefore must be seen as an attempt to prevent individual member states to set up such regulations and to set up joint and consistent regulations instead. It should also be noted that there is a risk of reverse modal shift where railways have difficulty financing retrofitting.

Another challenge is emerging for railway sector on the noise abatement issue: how to manage the problem of further lowering the maximum levels of noise during the night?

In its 7th Environmental Action Plan, the European Commission announced the objective to move the exposure to environmental noise significantly closer to the World Health Organisation recommendations by the year 2020. Moreover, a refit process has been launched, evaluating the so-called regulatory fitness of the Directive.

The World Health Organization (WHO) recommendations referred to by the Commission include very low noise levels identified in the Night Noise Guidelines (NNG), these are 55 dB Lnight as an interim target and 40 dB10 Lnight as an ultimate objective. 40 dB Lnight is significantly more stringent than commonly applied limits for new railway lines or new dwellings.

For railway lines with nightly freight traffic, it would be impossible to reach these levels within reasonable distance from the track, unless high noise barriers and in some cases tunnels and complete covers of the track would be installed. Achieving such low levels certainly in existing situations, could necessitate drastic and expensive measures like enclosures and tunnels.

If the recommendations of the WHO publication would be implemented and strictly enforced, this would have far reaching social and economic impacts, including making night time rail freight traffic virtually impossible. Implementing these limits to rail transport would almost certainly impede the other environmental advantages that rail transport offers, like low air pollution, low energy consumption and low land use.

3.3.3 Recommendation

The recommendations cover the following three main aspects:

- identifying effective technical measures;
- providing effective regulation and economic incentive schemes which do not distort competition with other transportation modes;
- funding the necessary investments.

All three aspects refer to particular European conditions.

3.3.3.1 Technical Measures

The classical approach to outdoor noise problems is to distinguish three options for mitigation:

- At the source (generally the most cost efficient),
- At the propagation path (by setting up barriers or by keeping distance),
- At the receiver (by installing sound proof windows).

Vehicle - track system

With rolling noise being the predominant source in railway noise, the control needs to be based on a system approach. The system to be looked at consist of:

- The vehicle, with the wheel, the brakes, the bogie or axle and the vehicle body, all connected by springs and dampers,
- The track, with basic elements the rail, the rail fixation with rail pads, the sleeper, the ballast and the sub-soil.

These two sub-systems meet at the contact patch between the wheel and the rail, it is the combined roughness at this location that causes the rail and the wheel to vibrate and radiate noise. Even apparently smooth surfaces have some roughness and can cause noise.

In this complex system, the following options can be considered for the vehicle and for the track

Vehicle

The most important option is reduce the wheel roughness by replacing the cast iron brake blocks (which cause rough wheels) by K- or LL-blocks or using disk brakes.

Figure 43 Noise level for various brake block types

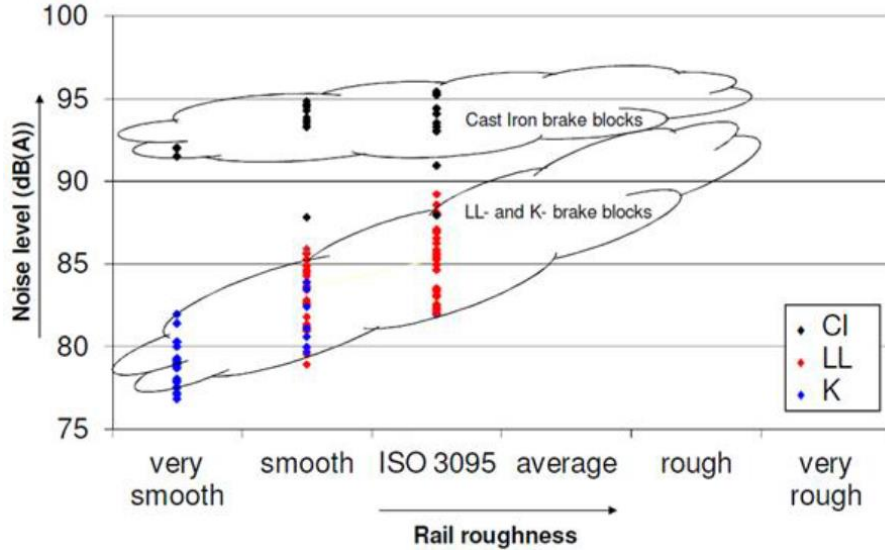

Source: DE VOS 2013

K-blocks are composite brake blocks used in new vehicle designs. The advantage of LL-blocks is that the braking system of the wagon does not need to be modified, whereas for K-blocks there is additional effort necessary besides changing the blocks. This is because LL-blocks have similar friction characteristics to conventional cast-iron blocks, whereas K-blocks have a higher coefficient (2.5 times higher). Both types (K- and LL-blocks) reduce noise levels by 8-10 dB; life cycle costs for K-blocks are similar to life cycle costs for cast iron brake blocks. The graphs below show a comparison between different friction coefficients of K-blocks vs. LL/CI (GG) blocks as a function of speed, demonstrating the difference between K and CI blocks and the equality of CI(GG) and LL blocks.

Figure 44 Friction coefficients of K-blocks vs. LL/CI (GG) blocks as a function of speed

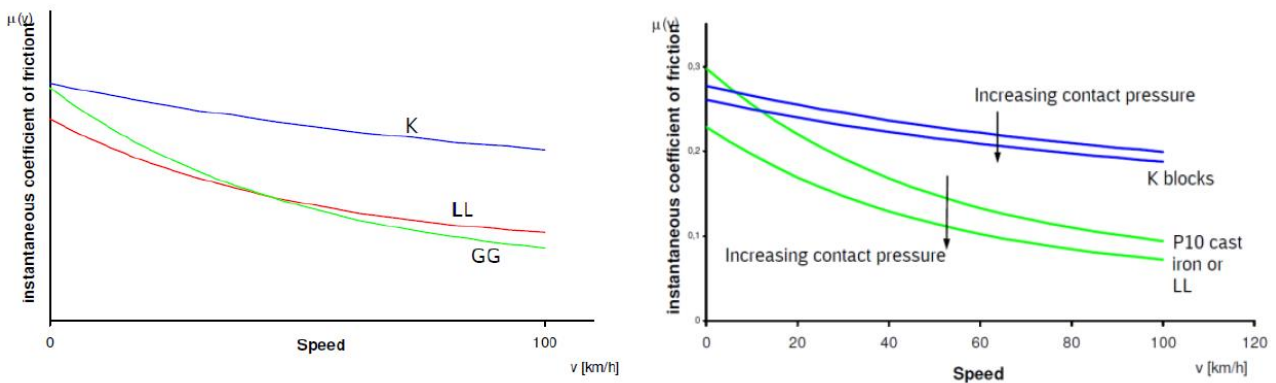

Source: MÜLLER-BBMA 2014

The problem encountered with LL blocks is that they work more aggressive on the wheel surface thereby destroying the cross profile. This implies more frequent re-profiling of the wheel surface. It is highly recommended to analyse the life cycle costs for LL-blocks concerning operation costs, because some manufacturers or wagon owners detected higher costs due to higher wheel wear. The LL-blocks require more frequent re-profiling of the wheels in order to maintain conicity. There exists no common understanding on the definition and the magnitude of the costs of retrofitting existing stock with LL or K

blocks. This is one of the factors that affects the smooth introduction of Noise Differentiated Track Access Charge on the European Network.

Disc brakes, which are prevalent in passenger vehicles, are typically about 8 dB quieter. With tread brakes, the brake blocks press against the wheel directly on the running surface (the tread), i.e., the wheel surface which is in contact with the rail; whereas with disc brakes an extra disc is placed on the axle and brake blocks press against this to brake the vehicle. Disc brakes are very expensive and can only be introduced with new freight wagons or expensive retrofitting of existing wagons (the whole bogie needs to be changed).

Fundamental redesign of the wheel to reduce noise is difficult due to the need to fit with existing tread braking systems and the need to dissipate the heat generated during braking. Resilient wheels can reduce noise and improve ride quality, and can be very effective at reducing squeal noise in tight curves. A variety of technologies are available and in use in high-speed and metro applications.

Another adoptable technology consist on screening off the noise radiated by the wheel with wheel shrouds (disc brakes mounted on the wheel may serve as wheel shrouds) or bogie enclosures. This measure is generally rejected by the operating companies because of the interference with visual inspection of the wheel and the axle box.

Optimise the size and the shape of the wheel in order to reduce its vibration is feasible in new vehicles but has a limited benefit.

Track

To reduce the rail roughness a regular monitoring and preventive/curative grinding is requested. Almost all networks monitor the geometric track quality as implement a regime of curative and preventive grinding but only a few networks currently monitor the acoustic quality (“roughness”) of the track on a regular basis. Acoustic grinding is applied only occasionally. In Germany, where a limited number of tracks is ground acoustically, a subtraction of 2,5 to 5 dB in the calculated noise level have been allowed.

Optimising the rail pad stiffness represents a technical option even if both track quality and acoustic quality need to be taken into account.

Adding a (tuned) rail damper – steel masses embedded in an elastomer, fixed to the rail web can also be used to reduce noise levels, but rail dampers can make barriers and screens unnecessary. Noise and ground-borne vibration are a major concern in urban areas, and bridges and underground railways require special measures.

Figure 45 Tata Steel SilentTrack tuned rail dampers

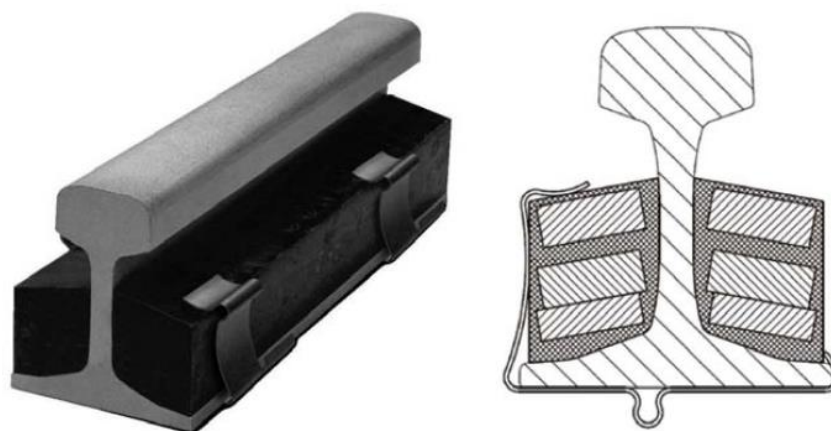

Source: EU DG INTERNAL POLICIES 2012

Resilient rail pads are a common solution, but for locations where a greater level of damping is required then floating or isolated slab track is a possibility, or under-sleeper pads and ballast mats for ballasted track.

An alternative to rail pads is a more advanced resilient rail support system. Resilient rail support solutions interact with each other and also with resilient wheel technologies, and the whole system needs to be considered and modelled in order to minimise noise and vibration in the required frequency range. Rail dampers can be tuned to the local needs of the railway and left in place for the life of the track.

Approximately 240 km of rail dampers have been installed in Germany, Czech Republic and The Netherlands. In some networks the test results gave disappointing results and rail dampers have since been discarded (due to safety issues; rail wear, with negative noise effects). The reason for this difference is probably the regional preference for either “hard” or “soft” rail pads. Rail dampers are expected to be more efficient the softer the rail pads. Rail dampers are costly, although their increased application has reduced the purchase cost. The effectiveness is limited to 0 to 3 dB(A) depending on the characteristics of the wheel rail system they are applied to. Some questions remain regarding increased maintenance cost, safety issues (occurring when rail dampers are loosening from the rail or due to excessive rail corrugation) and impact on rail roughness growth (both positive and negative effects are reported).

Noise barrier

Noise barriers are applied in many cases, both with new rail infrastructure, significantly changed infrastructure and as noise abatement in existing situations. As the dominant noise source (the wheel rail contact surface) is close to the track, noise barriers are highly effective as long as the receiver position is in the shadow zone (i.e. there is no direct sight from the receiver to the source). Most noise barriers near railway lines are between 1 and 4 meters high, but very high barriers (up to 10 meters) are erected in exceptional situations. The key parameter for the barrier effectiveness is the geometry, i.e. the location of the upper edge of the barrier with respect to the source location.

Figure 46 Illustration of the “canyon” effect and how it can be prevented by an absorptive lining

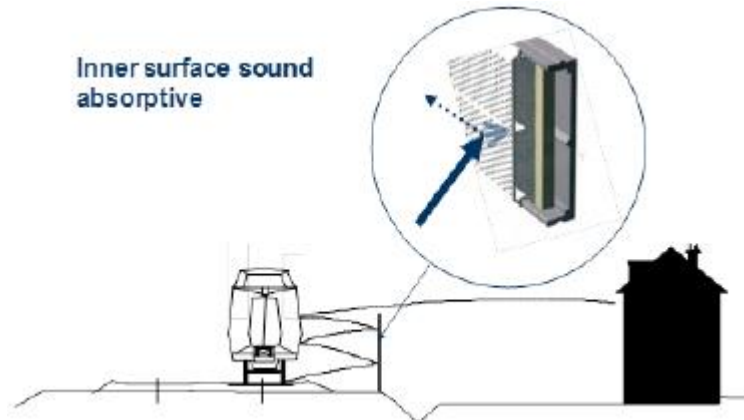

Source: UIC 2016

Well designed and located noise barriers can be effective with attenuation of 10 dB(A) or more at the façade of the receiver. In some types of new train design items of auxiliary equipment (even including the diesel engine) have been mounted on the roof of the coaches. This design significantly affects the efficiency of noise barriers, which would then have to be built higher to have the same effect as for more conventional rolling stock design. Pantographs are generally higher than noise barriers, and for high-speed trains these are a major source of noise. Rather than making noise barriers even higher or all-enclosing, an alternative approach is to focus on aerodynamic design and new materials.

Façade Insulation

Usually, when installing barriers, a cost efficiency consideration is made. For a single house at some distance from the track, a barrier would have to represent substantial length of track, and would most likely

turn out to be very costly. In this case the most efficient solution is constituted by acoustic insulation of the facade and of the windows of the affected dwellings.

Depending on the legal limits the façade insulation must be improved from a standard glazing (typically 15 dB for single glazing to 20 dB for thermal double glazing) to a sound proof glazing with up to 33 dB insulation. Ventilation is provided either by a forced airflow through silencers or a natural airflow through special sound proof devices.

Sound proofing has limited interference with the normal housing design in climate zones with severe winters (Scandinavia) but can have a higher interference in warmer climates and houses without air-conditioning.

The following table shows a summary of measures and effects, collected from the different sources.

Table 5 Measures and effects

Measure	Avoided source of noise	Impact	Effect
K-blocks	Rolling noise	network wide	Up to 8 dB(A) – 10 dB(A)
LL-blocks	Rolling noise	network wide	Up to 8 dB(A) – 10 dB(A)
General grinding of bad track	Rolling noise	local	10 – 12 dB(A) (up to 20 dB(A) at very bad tracks)
Special acoustic grinding	Rolling noise	local	1 – 4 dB(A) (depending on local rail roughness conditions), mostly around 2 dB(A) attended
Disc brakes	Rolling noise	network wide	10 dB(A)
Wheel-tuned absorbers	Wheel noise	network wide	2 – 7 dB(A)
Bogie Shrouds together with low height barriers	Wheel noise	local	8 – 10 dB(A)
Rail dampers	Rail Noise	local	3 – 7 dB(A) (mostly around 3 dB(A) attended)
Slab tracks	Rail noise	local	5 dB(A)
Rail pads	Rail Noise	local	3 – 4 dB(A)
Different measures to lower squeal noise	Squeal noise	local	Up to 20 dB(A) depending on local conditions
Shielding of pantographs	High speed trains	network wide (high speed up from 200 km/h)	5 – 10 dB(A)
Barriers 2 meter high	All sources	local	10 dB(A)
Barriers 3 – 4 meter high	All sources	local	15 dB(A)
Insulated windows	All sources	single house	10 – 30 dB(A)

Source : EU DG Internal Policies 2012

Regarding the costs and the associated effects, and current experience of noise measures, the conclusions are:

- Noise should ideally be reduced at the source because these measures have a network-wide effect.
- A relatively cheap way to reduce noise on freight routes is to retrofit braking systems of rail freight wagons with composite brake blocks as quickly as possible.
 - Freight trains are currently identified as the noisiest trains.
 - Most freight trains operate at night which is the most sensitive time of day.
 - Most passenger trains already have disc brakes due to higher speeds and enhanced comfort for passengers, so these trains are quieter than freight trains.
 - Wheel dampers are very expensive and cause additional efforts for maintenance but can significantly reduce noise emission.
- In case of high-speed trains, advanced pantograph designs should be considered, especially for routes through noise-sensitive areas where noise bunds and barriers shield against rolling noise but may not shield pantograph noise.
- Where track infrastructure causes increased noise levels (e.g., structure-radiated noise from viaducts or curve squeal in narrow radius curves), or where the local environment is particularly sensitive to noise (e.g., urban environments with residences very close to the railway line (especially

agglomerations) or areas of natural beauty) then additional trackside noise mitigation measures may be necessary.

- Rail-tuned absorbers can be effective against curve squeal and rolling noise, reducing noise levels typically by 3-7 dB(A). These can be a low-cost solution which avoids visually intrusive noise barriers.
 - Noise bunds and barriers can be effective against noise propagation, but can create problems for track access and have high on-going maintenance costs.
 - Curve squeal and corrugation of the low rail can be prevented using top of rail friction modifiers.
- In the long term, new wheel concepts can be introduced, but these need more research and testing before they can be introduced especially into high speed vehicles.
 - In dense populated areas with high frequencies of trains, noise protection walls or insulating windows still need to be introduced. Their number could shrink in case of well introduced source related measures or modified tracks.

3.3.3.2 Regulation and economic incentive schemes

In the European context a sound regulation scheme is the heart of any successful pollution reduction strategy. This holds in particular for noise, because an effective reduction of noise through vehicle-related measures presupposes that almost all internationally operating rail wagons are equipped with low-noise technology.

The TSI Noise is an appropriate basis for noise regulation in the medium and long term. The standards for noise emissions can be valid for new or modified vehicles only or for all wagons and in the medium and long-term view the TSI Noise, for example, will become compulsory for all vehicles circulating in Europe. The noise levels of a noise standard emission should also be lowered from time to time according to technical development.

Economic incentive schemes consist of charging and bonus/penalty systems. This is feasible where a charge system exist as in European railway network following the Railway Package. Rail track charging is an important element of an incentive-compatible penetration strategy for low noise rail technology.

This means that a balance between competitive transport modes and rail pricing for noise emissions need to be established.

Further alternative or complementary incentives can be introduced through bonus/penalty systems. In particular, in the transitory phase, bonus payments can motivate the rail car operators to switch to new technology as early as possible. The railway companies will call for wide use of this instrument if the state pays for the bonus. From the viewpoint of setting incentives right, at least a part of financial contributions should be covered by the rail car owners/operators.

3.3.3.3 Funding schemes

After assessing the best combinations of technical and economic measures, the financial implications have to be considered and the impacts on stakeholders have to be analysed.

European rules allows that infrastructure-related measures are financed by the state and/or the rail infrastructure managers. In the latter case, the additional costs for the infrastructure managers are passed on to the railway undertakings through the rail track charges. This implies that the state will have to cover a substantial part of the infrastructure-related costs if the competitive balance between road and rail is not to be affected.

To avoid market distortions vehicle-related measures have to be financed by the car owners/operators in the long term. The vehicle-related funding scheme should be focused on retrofitting existing vehicles. Funding and regulation schemes should be harmonised to minimise distortions of competition as many freight transport companies are operating internationally, carrying a high share of freight rail cars cross-border. Therefore a common regulation scheme is necessary, accompanied by a widely harmonised system

of pricing and funding. Variations from this general rule could only be accepted to the positive side, i.e., to motivate top runners to start early with appropriate actions. In this context, the trade-off between low noise policy and competition policy could be more balanced in favour of low noise in the medium-term.

The reason is that rail freight as a whole may lose market share in the medium term if the noise problems cannot be solved appropriately, and the resistance of the affected population might impede full capacity utilisation and the removal of capacity bottlenecks.

3.4 Air Pollution

Exhaust emissions from diesel traction is one of the challenging areas for the railways, especially for the further development of commuter transport from rural to urban areas with possible environmental restrictions. Legislation will drive further the necessary improvements in the short and medium term in this field, and that is also why the railways should aim at establishing a long term vision and strategy with appropriate targets and a road map in order to take the lead. This will require substantial cooperation with other partners such as engine manufacturers and system integrators.

With targeted application of new traction concepts and improvements of existing diesel traction units, it should be possible to achieve the targets and reduce risks of inhibiting further transport growth caused by political and social opposition to current rail emission levels.

3.4.1 Current situation

The electrified railway network has doubled in length between 1975 and 2013, totalling 221 000 km of tracks in 2013. At European level, 61% of railway transport takes place using electric traction in 2013, while the remainder is diesel traction that represents a significant source of exhaust emissions (PM and NO_x).

Figure 47 Length and share of electrified and non-electrified railway tracks, 1975-2013 (thousand km)

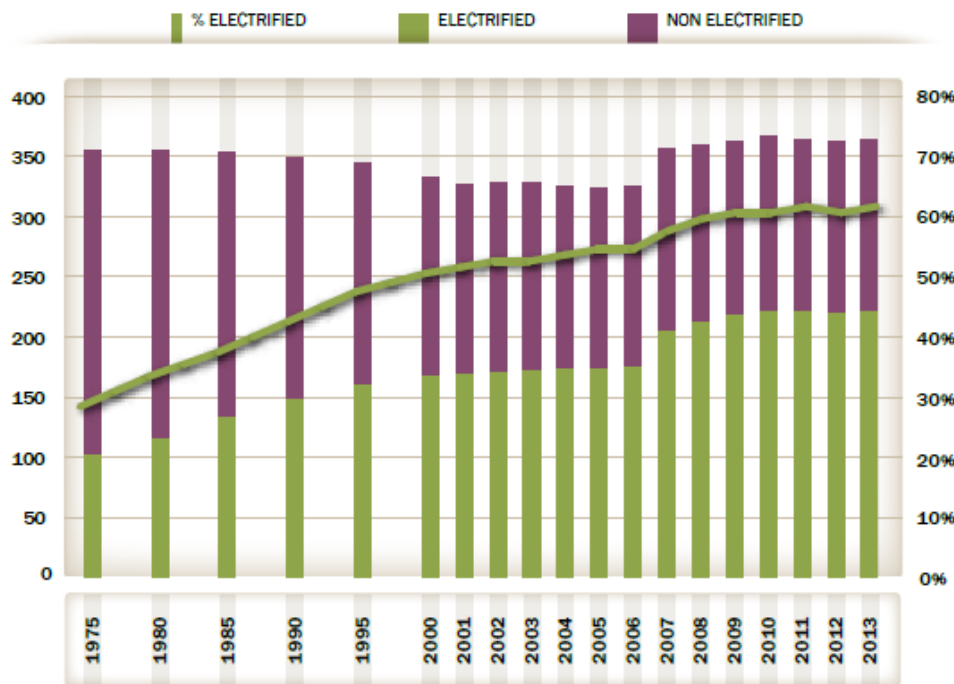

Source: UIC IEA Handbook 2015

According to the data provided by the ESRS project, that collects and elaborates data on PM and NO_x since 2011/2012, the total particulate matter emissions have been reduced by 23% in 2013 from the 2005 baseline, which is about 10% more than the linear performance expected in 2013 (shown in the figure below).

Figure 48 European railway sector total particulate matters (PM) emissions, 2013 (Thousands tonnes)

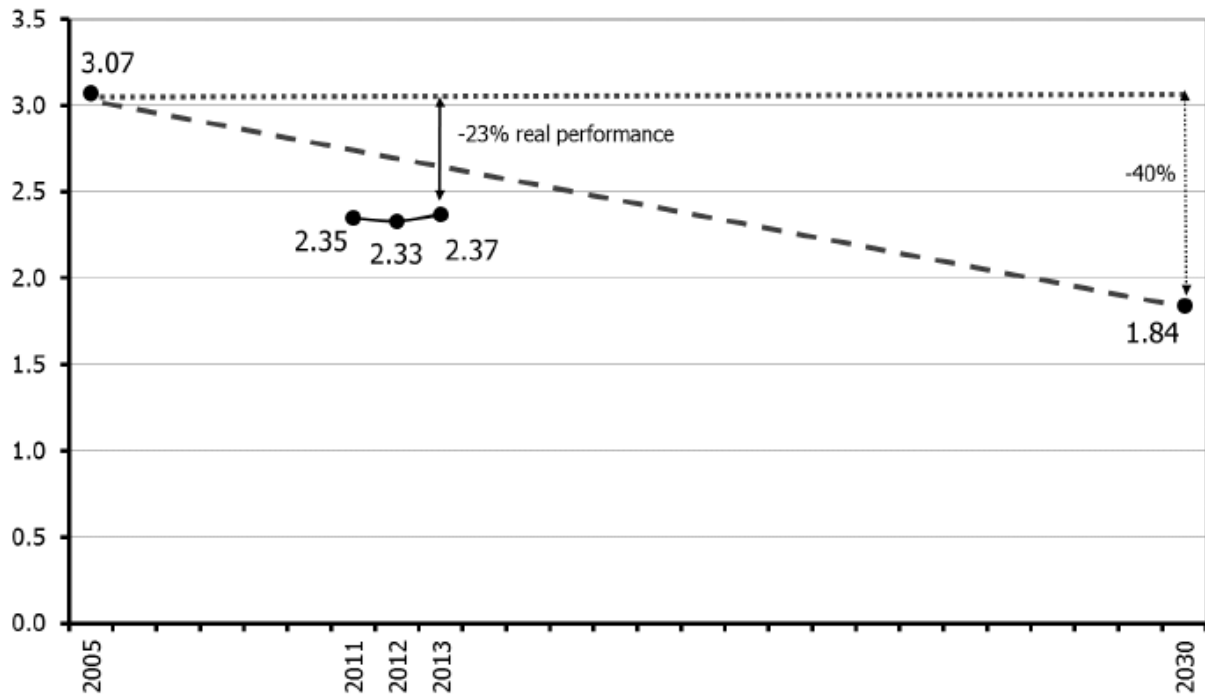

Source: UIC 1990-2030 Environment Strategy Reporting System – 2015 Report

With regard to the total nitrogen oxides (NO_x) emissions, they have been reduced by 26% in 2013 from the 2005 baseline, 13% more than the expected linear performance.

Figure 49 European railway sector total nitrogen oxides (NO_x) emissions, 2013 (Thousands tonnes)

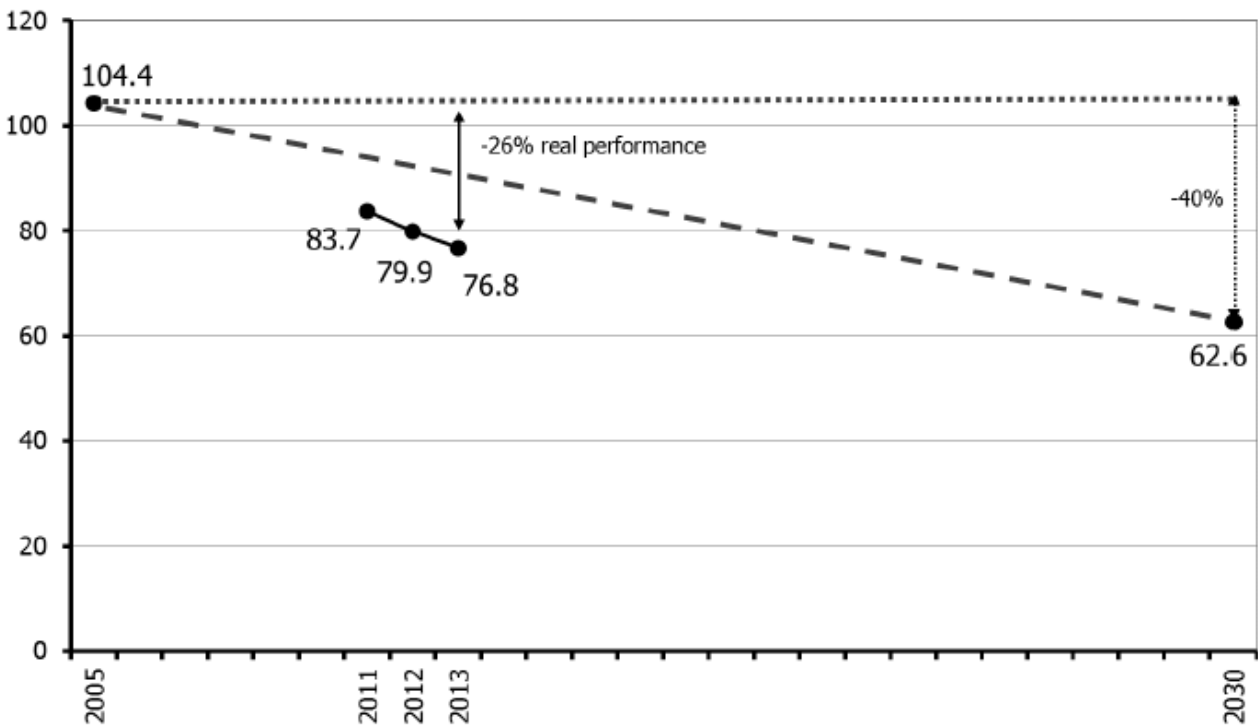

Source: UIC 1990-2030 Environment Strategy Reporting System – 2015 Report

The performances of the European railway sector on exhaust emissions (both for PM and NO_x) are well below the linear path that reaches straight to the correspondent targets for 2030, even if with different trends.

Political and legislative perspective

European emission standards for engines used in new *non-road mobile machinery* (NRMM) have been structured as gradually more stringent tiers known as Stage I-V standards. Stage I-IV regulations for diesel engines were specified by Directive 97/68/EC and five amending Directives adopted from 2002 to 2012. The political focus on rail exhaust emissions has been quite significant since the Non Road Mobile Machinery Directive (2004/26/EC or simply 'NRMM') was updated to include diesel multiple units and locomotives. Before their inclusion in the NRMM, the UIC leaflet 624 regulated rail emissions.

Stage III A and III B standards have been adopted for engines above 130 kW used for the propulsion of railroad locomotives (categories R, RL, RH) and railcars (RC) (Table 6) while there are no Stage IV standards for rail traction engines.

Table 6 Stage III A/B Emission Standards for Rail Traction Engines

Category	Net Power	Date	CO	HC	HC+NOx	NOx	PM
	kW						
Stage III A							
RC A	P > 130	2006	3.5	-	4.0	-	0.2
RL A	130 ≤ P ≤ 560	2007	3.5	-	4.0	-	0.2
RH A	P > 560	2009	3.5	0.5*	-	6.0*	0.2
Stage III B							
RC B	P > 130	2012	3.5	0.19	-	2.0	0.025
R B	P > 130	2012	3.5	-	4.0	-	0.025
* HC = 0.4 g/kWh and NOx = 7.4 g/kWh for engines of P > 2000 kW and D > 5 liters/cylinder							

Source: DieselNet 2016

Proposed Stage V emission standards would apply to engines used for the propulsion of rail locomotives (RLL) and railcars (RLR) of any power rating and any type of ignition. The proposed limits are shown in Table below. Auxiliary engines used in locomotives or railcars should meet emission standards for categories NRE or NRS.

Table 7 Stage V Emission Standards for Rail Traction Engines

Category	Net Power	Date	CO	HC ^a	NOx	PM	PN
	kW						1/kWh
RLL-v/c-1 (Locomotives)	P > 0	2021	3.50	4.00 ^b		0.025	-
RLR-v/c-1 (Railcars)	P > 0	2021	3.50	0.19	2.00	0.015	1×10 ¹²
^a A = 6.00 for gas engines							
^b HC + NOx							

Source: DieselNet 2016

3.4.2 Challenges and limitations

Several measures has to be developed and implemented in major parts of the rolling stock as well as for supporting measures (information, communication) and operational planning in order to reach the exhaust emission goals of reduction.

Economic and market perspective

Future increasing of energy and CO₂ prices could lead to significantly higher operational costs and railways could be influenced by them. This will allow for other and more energy efficient technologies to be implemented. The main problem however is that the costs of new, clean engines are quite high due to the small market and the high migration costs from road to rail. For new rolling stock it is less of a problem but for existing rolling stock there is often no business case for the railways to exchange their engines if the vehicles are way beyond the middle of their expected life span.

Society and customer perspective

The positive implications of having reached the exhaust emission target for traction is that the rail sector can demonstrate its sustainability performance to customers as well as governments and thereby receive increased support for further investments in railway infrastructure as well as upgrades to handle the growing capacity needs.

Technical and organisational perspective

The main technical measures to reach the 2030 target are not known at present – but some prototypes in various stages exists for stage IIIB due in NRMM in 2012. Technical measures to reduce exhaust emissions from railway operation can basically be split into two parts:

- 1) Exhaust emission improvements in the diesel traction chain
- 2) Alternative traction types

One barrier (risk) for exhaust emission is the long lifespan of rail vehicles which prevents a fast implementation (NOx and PM performance improvement) with regards to exhaust emission measures. One important support measure would be to establish and add updated and trustworthy exhaust emission data to the current UIC energy and CO₂ database in order to update the performance improvement until 2030 and 2050.

Figure 50 Locomotives fleet development by 2020 - CleanER-D Project scenarios

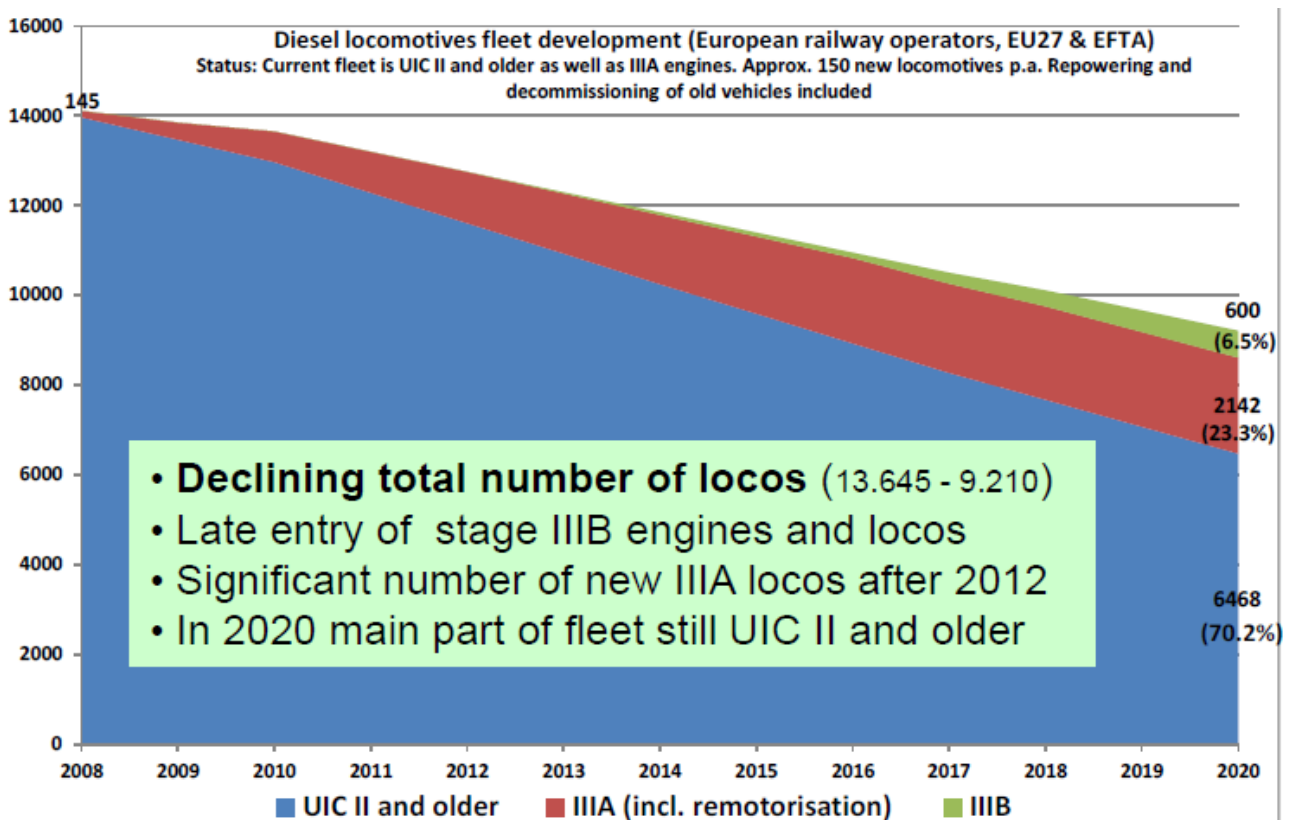

Source: "Fleet scenarios, emission reduction & energy efficiency potentials" Presentation by Roland Nolte, IZT Berlin, Germany – UIC Wien Conference 2016

Figure 51 DMUs fleet development by 2020 - CleanER-D Project scenarios

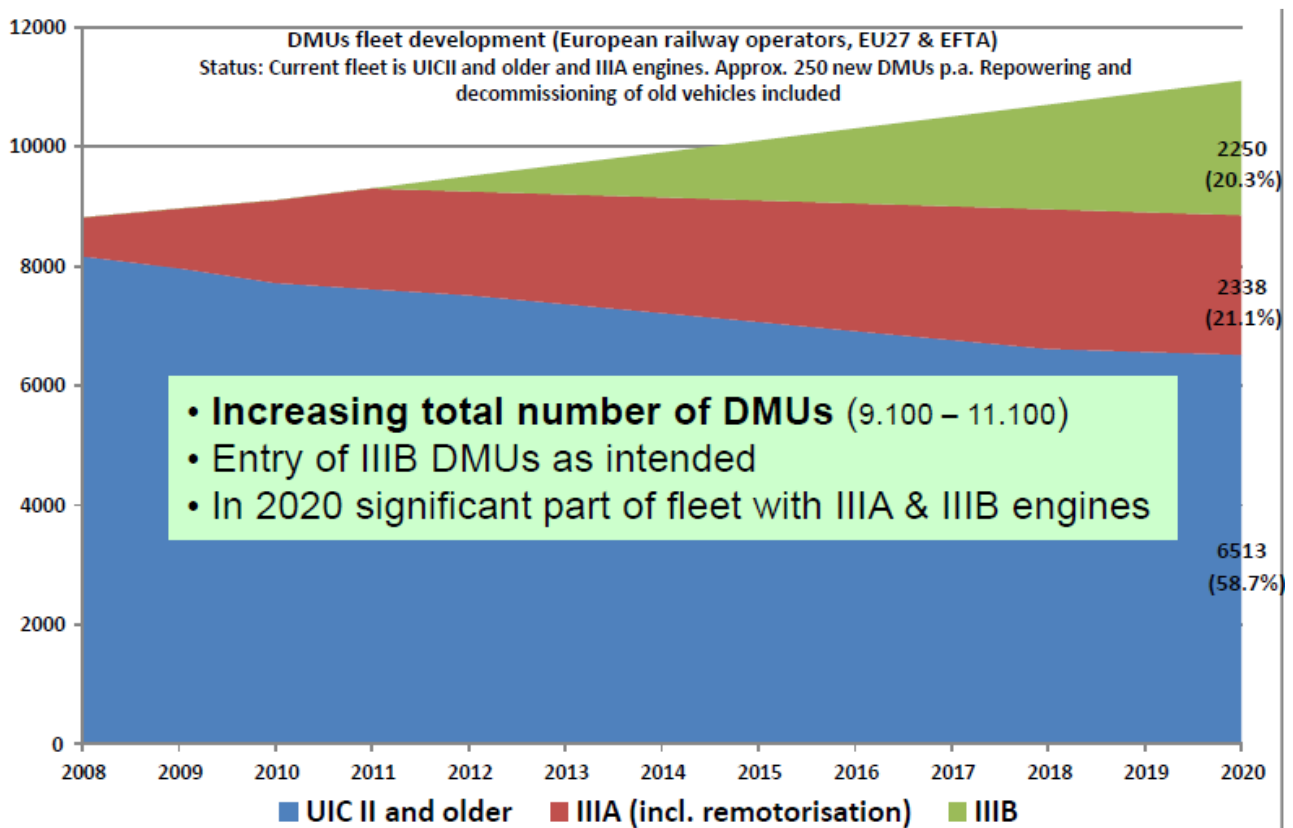

Source: "Fleet scenarios, emission reduction & energy efficiency potentials" Presentation by Roland Nolte, IZT Berlin, Germany – UIC Wien Conference 2016

Exhaust emissions monitoring – The ESRS project

The PM and NO_x emissions are calculated with 3 different methodologies (called "levels") within the European ESRS project, according to the data that can be provided by the railways:

- Level 1 (expert): the railway can provide directly its total annual PM and NO_x emissions. It should also specify the methodology used for calculating those emissions.
- Level 2 (intermediate): if the railway is not able to provide its total annual PM and NO_x emissions, but it is able to provide data concerning the composition and the detailed consumption of its diesel traction fleet (specified by series), then PM and NO_x emissions will be automatically calculated from that data by using standard PM and NO_x emissions factors for traction diesel engines in railway tractive stock (locomotives and MUs).
- Level 3 (basic): if the railway cannot provide its total annual PM and NO_x emissions, nor is it able to provide composition and detailed consumption data for its diesel traction fleet (specified by series), then a proxy method will be used to calculate PM and NO_x emissions based on total diesel consumption and an average composition of the diesel fleet.

The data requested to railways for the calculation of PM and NOx emissions is shown in the following table:

INDICATOR	DEFINITION
4.1 Total PM emissions (tonnes)	PM emissions of traction for the railway and methodology used to calculate them
4.2 Total NOx emissions (tonnes)	NOx emissions of traction for the railway and methodology used to calculate them
4.3 Diesel consumption per series	Diesel consumption for all series (emission classes) of tractive stock.

The indicators have to be filled out according to the availability of data.

- Railways that can provide total annual PM and NOx emissions (Level 1) will have to provide data for indicators 4.1 and 4.2.
- Railways that cannot provide total annual PM and NOx emissions, but are able to provide data concerning the composition and the detailed consumption of their diesel traction fleet (Level 2) will not fill indicators 4.1 and 4.2, but will provide data for indicator 4.3.

Railways that cannot provide the above data can leave these indicators blank. A proxy method (Level 3) will be used to estimate their PM and NOx emissions. In this case, in order to support the calculation of PM and NOx exhaust emissions from diesel traction for each railway, the following data have been collected by UIC about the diesel fleet of railways:

- Diesel fleet composition by series, for DMUs/railcars and different types of locomotives, in particular:
 - Emission performance of engines;
 - Number of units and engines for each type of DMU/railcar or locomotive;
 - Power of traction engine;
 - Average annual mileage per vehicle (in train-km and gross tonne-km).

The diesel fleet composition by series are updated by UIC every three years by sending to all UIC members a questionnaire on diesel fleet composition.

For the level 1, the emissions have to be indicated in tonnes. The methodology used by the railway to calculate the emissions has to be specified. It is possible to insert references to documents where the methodology is described in more detail.

In the case of level 2, the diesel consumption (in tonnes) has to be specified for all the categories listed in Annex II of the ESRS methodology:

- DMUs/railcars with power greater than 130kW (Pre-UIC, UIC I, UIC II, IIIA and IIIB)
- Locomotives with power between 130 and 560 kW (Pre-UIC, UIC I, UIC II, IIIA and IIIB)
- Locomotives with power between 560 and 2,000 kW (Pre-UIC, UIC I, UIC II, IIIA and IIIB)
- Locomotives with power greater than 2,000 kW (Pre-UIC, UIC I, UIC II, IIIA and IIIB)

The categories Pre-UIC, UIC I, UIC II, IIIA and IIIB are the exhaust emission regulation stages of diesel engines, defined in UIC (2012) for UIC I and UIC II, in EC (1997) (and its amendments) for stages IIIA and IIIB. Pre-UIC is a term used for all railway diesel engines not complying to emission limit stages as defined in UIC (2012) or EC (1997) and its amendments and brought into operation before the coming into force of UIC I

emission stage15. The power class classification has been made according to EC (1997) as the currently valid legislation.

3.4.3 Recommendation

The overall approach for climate protection and adaptation, energy efficiency and exhaust emissions is closely correlated. As already explained in the dedicated chapter, the European railway operators have set targets of exhaust emissions (PM and NOx) reduction in the framework of the EES Strategy: -40% by 2030 (baseline 2050) and zero emissions by 2050. The main reason for setting targets on exhaust emissions is to minimise, even avoid the risk that railway air pollution could become a barrier, or even inhibit future railway transport growth, especially for urban agglomerations with high population density. In the current unsustainable transport situation railway transport could contribute significantly to overall society objectives if rail is capable and enabled to take over traffic from other modes of transport, mainly road and air transport – for personal mobility and freight transport. The overall sustainability of railway transport is reflected in the low external costs compared to other modes of transport and in the external costs avoided by the introduction of most advanced diesel engine technology as shown in the Figure 52.

Figure 52 Avoided external costs from introduction of NRMM stages IIIA/IIIB

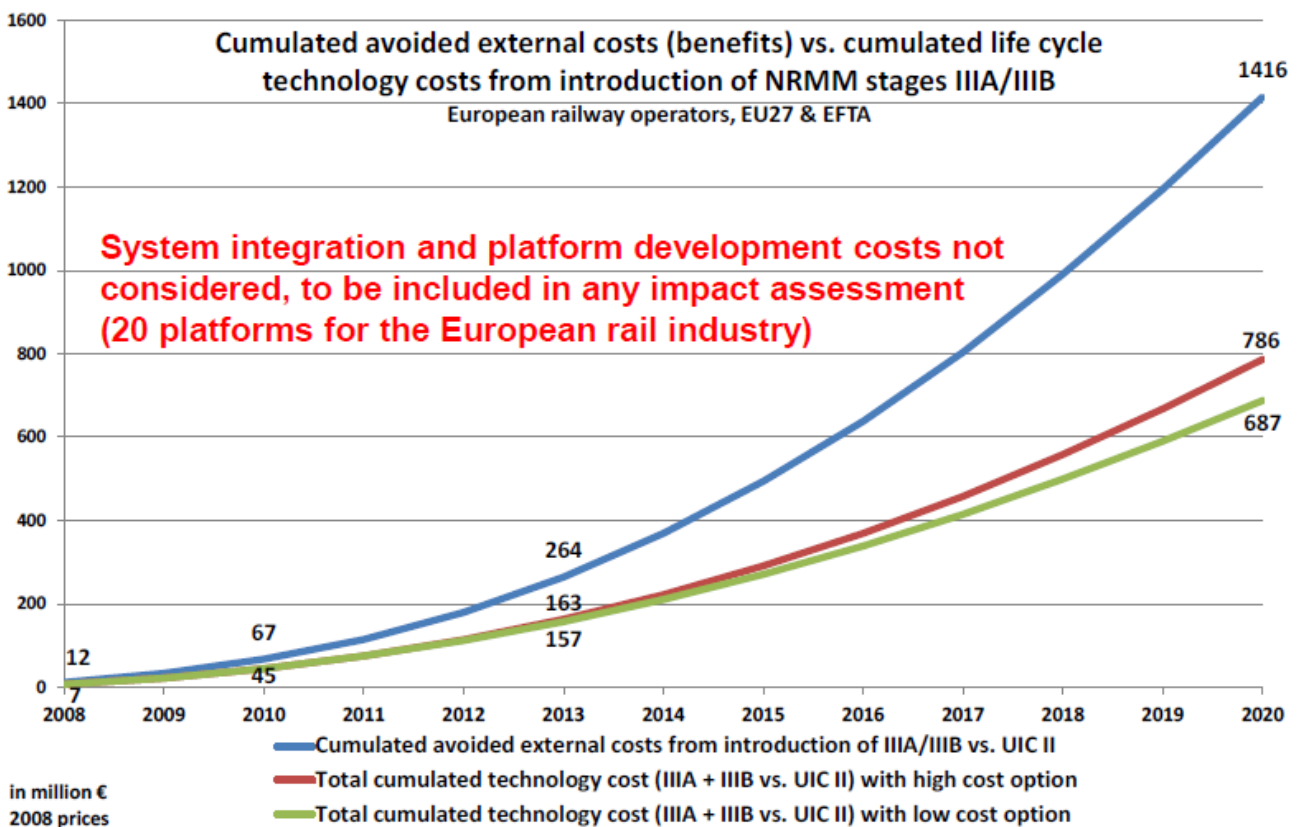

Source: “Fleet scenarios, emission reduction & energy efficiency potentials” Presentation by Roland Nolte, IZT Berlin, Germany – UIC Wien Conference 2016

The problem for exhaust emissions has mainly been the existing fleet of often very old diesel tractive units which have considerably contributed to overall emission levels in local urban settings e.g. from stand still in depots or at terminal stations. This has added to the myth of diesel operation being old fashioned and not significantly improving. In reality tremendous improvements have happened which are now also slowly being acknowledged at the political level and further improvement could come from the introduction of stage V of the NRMM.

To build a system of data collection, processing and monitoring of data on pollutant emissions is certainly the most important challenge in order to monitor any kind of improvement or trend. This is the reason why a methodology for the monitoring of PM and NOx emissions has been included in the ESRS system.

3.5 Recyclability and Materials

The EU circular economy approach, which is a relevant part of the green economy systemic approach, is aimed at addressing policies to manage products and production processes in a life cycle perspective with the goal of creating value for the economy and avoiding deterioration of natural environment and depletion of natural earth resources.

Figure 53 The focus area of the circular economy and the green economy

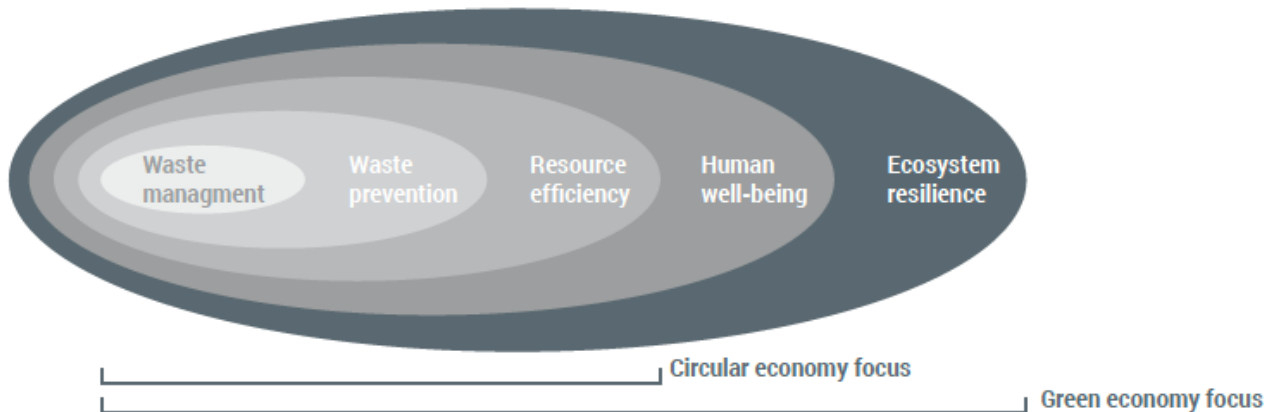

Source: European Environmental Agency, 2014

In this respect, the Action Plan for the circular economy proposed by the European Commission in December 2015 [EU-CE, 2015], is aimed at allowing that *“the value of products, materials and resources is maintained in the economy for as long as possible, and the generation of waste is minimised”*. Accordingly, this goal can be achieved by enforcing existing policies, and/or by defining other supportive instruments, to boost the innovation in product design, in sustainable materials, in production processes engineering, as well as by introducing more challenging material recovery targets in waste stream management.

The proposal emphasizes the importance of enabling the industrial systems to better design products at the early stage of engineering, so to make them more durable, easy to repair, upgrade or remanufacture, as well as to allow recyclers to easily proceed with disassembly at end-of-life in order to recover valuable materials and components, so to allow best circularity performances according to the scheme reported in Figure 54.

Figure 54 The circular economy loops

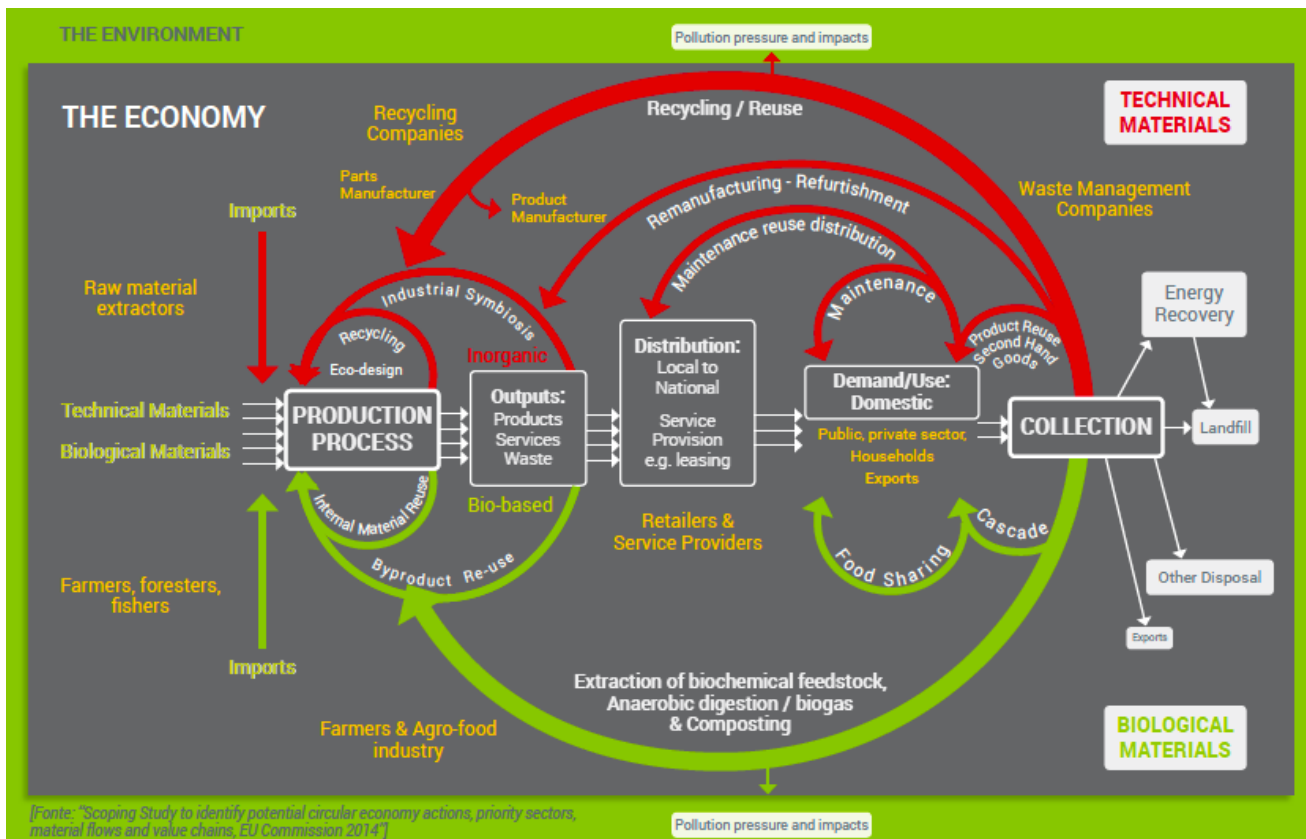

Source: "Scoping study to identify potential circular economy actions, priority sectors, material flows and value chains", EU Commission, 2014

Among the others, a valuable EU experience of waste management towards circularity dates back to early this century and is related to the management of end-of-life vehicles produced every years in the EU (over 6 million ELV, in 2012). The entering in to force of the Directive 2000/53/EC [EU-ELV, 2000], introduced mandatory recovery targets to Member states for ELVs (a minimum of reuse and recovery of 95% by an average weight per vehicle, by 2015), has brought to a consistent improvement in ELV components reuse and material recycling, reducing the amount of disposed hazardous wastes. Furthermore, it addressed a change of the manufacturers' production models in the direction of improving vehicles recovery and recycling towards the improvement of design and materials sourcing (see Figure 55).

According to the high-value of energy and materials embedded in the ELVs, the new EU circular economy proposal will foster new measures for this waste stream management to further prevent precious raw materials leakage.

Figure 55 - Recovery and recycling rates of end of life vehicles in Europe, 2013

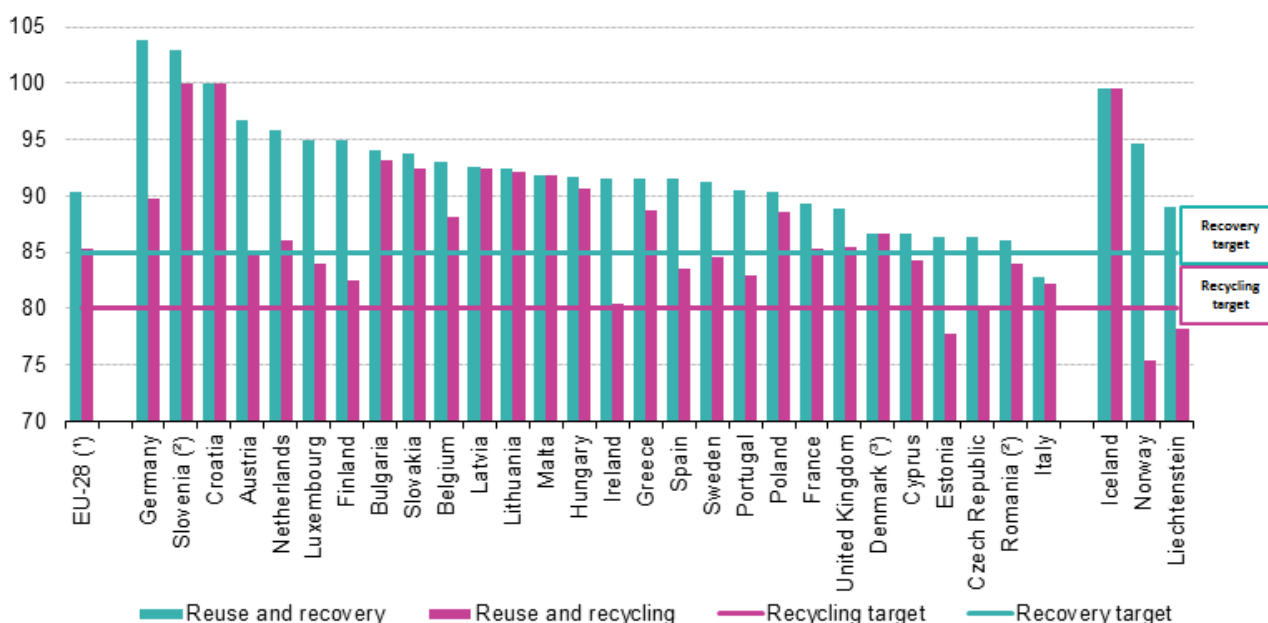

Note: ranked on 'Reuse and recovery'.

(*) Eurostat estimates.

(*) 2012 data.

(*) Estimates.

Source: Eurostat, "End-of-life vehicle statistics" website (last visited 2 December 2016)

Another relevant issue addressed by the new EU circular economy package of proposals is related to the construction and demolition waste stream (871 million tonnes generated in 2014, which accounts over 33% of the total waste generated in Europe), which has been identified as a priority stream due to the high potential for recycling and re-use of materials, since some of its components have a high resource value (i.e. aggregates derived from CDW can be re-used in roads, drainage and other construction projects).

The recycling of CDW is encouraged by mandatory targets set in the Waste framework Directive 2008/98/CE [EU-WFD, 2008] (by 2020, a minimum of 70% -by weight- of non-hazardous construction and demolition waste, excluding a list of naturally occurring materials, shall be prepared for re-use, recycling or other material recovery), but the level of recycling and material recovery of CDW varies greatly across the EU (see Figure 56) and new challenges on the ground still have to be addresses to improve.

According to a recent EU impact assessment, if not separated at source, CDW can contain small amounts of hazardous wastes, the mixture of which can pose particular risks to the environment and can hamper recycling. In this respect, the Commission circular economy proposal states that targeted guidelines will be developed to promote better recycling practices, including on the treatment of hazardous waste, to improve sorting systems.

Figure 56 - Construction and demolition material recovery and backfilling in Europe, 2011

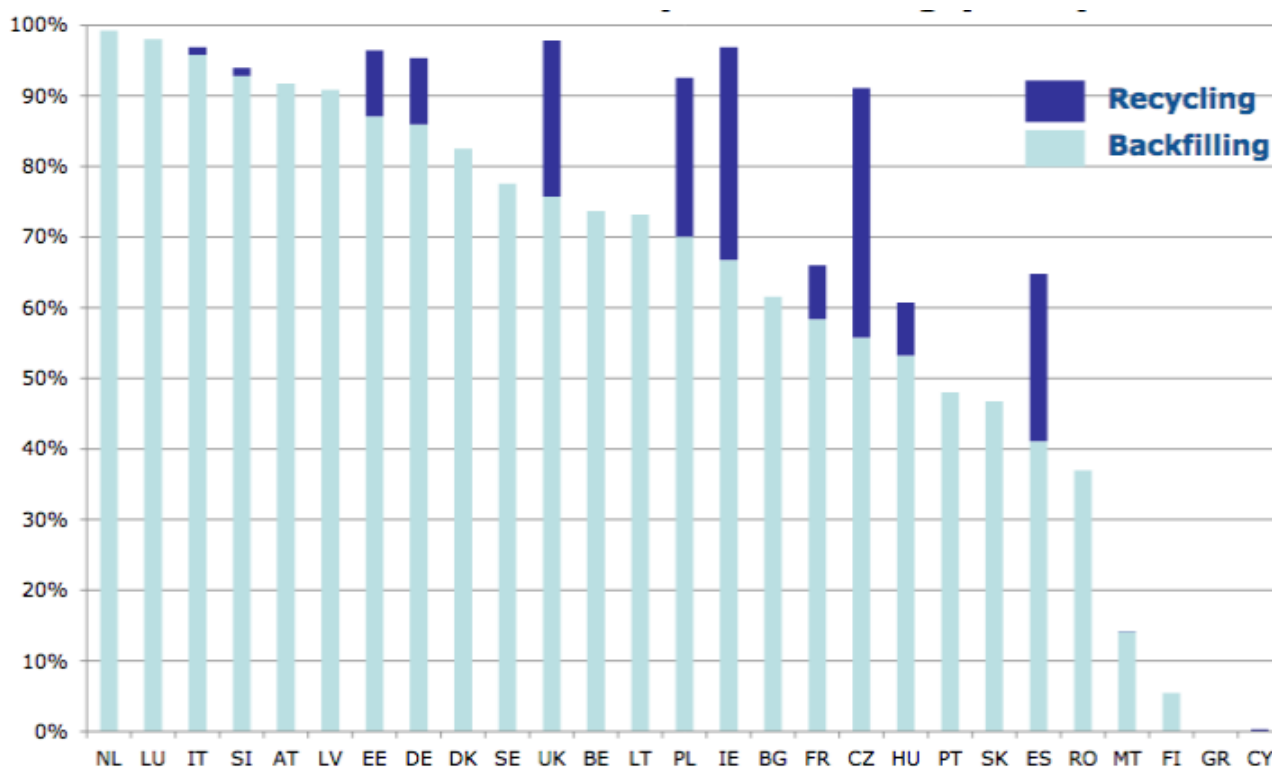

Source: EU Commission, "Construction and demolition waste" website (last visited, 2 December 2016)

As for both the above mentioned examples, and many others, the EU common framework of policies for sustainable development has favoured, and still do, opportunities for a green growth along the sectorial industry value chains, allowing to boost performances in waste management and unlocked new potential for improvement in the frame of the circular economy.

In the case of the railway sector, the lack of a EU specific regulation, so far recycling of end-of-life rolling stock and other infrastructure elements such as track, sleepers, ballast and track foundation, catenary, ecc., was carried out because of the economic benefits that could be derived from the recovery of parts and components used as spare parts and from the recovery of some secondary raw materials, without a systemic approach aimed at resource efficiency and environmental impact reduction. In the recent years, however, the numerous initiatives in this direction implemented by voluntary agreement between manufacturers and operators, unlocked the opportunity of developing a systemic circular economy strategic approach to boost the recyclability of railway products by design and improve the railway transport sector green performances also in this context.

3.5.1 Current situation

For railway transportation, the advantage of rail vehicles, compared to road vehicles, is its potential for sustainable development and the care for the environment cannot only pertain to the phase of operation of the vehicles, but must include also other phases such as the production or the end-of-life phase. In this respect, in 2014, the European Railway Operating Community has published the "Rail Technical Strategy Europe" [CER, 2014] in which the sustainable development goals for the railway sector are linked to a systemic life cycle thinking approach to improve the efficiency of the whole railway sector in terms of economics, social and environmental aspects.

Within this approach, particular emphasis is given to opportunities of adopting a sectorial frame of reference common rules for asset management in a life cycle perspective, with focus on recyclability rolling stocks.

Rolling stock recyclability

Due to their high value contents in precious materials and components, the recycling of rolling stocks brings measurable economic benefits. Rail vehicles are built from many types of materials such as metals (ferrous and non ferrous) composing the main structure, polymers, glass, various modified organic natural materials (such as wood, cardboard, leather, ecc.), various fluids, as well as other materials and components of the electrics and electronic systems. If managed in appropriate technical schemes, most of these materials and components can be recovered at end-of-life by contributing, on one hand, to the reduction of primary raw materials extraction and consumption, mitigating the resource depletion in the environment, and on the other hand to avoid those environmental impacts related improper management or disposal, such as ground and water contamination with embedded hazardous substances, ecc.

As reported in Figure 57, according to the EU legislation, in terms of environment protection in railway transport, only few technical areas (noise, exhaust emissions, electromagnetic fields, ban on the use of certain materials) have been regulated, while actions related to recycling of rolling stock result from voluntary regulations of the organizations associating the rolling stock manufacturers and operators as well as individual strategies realized by key stakeholders.

Figure 57 - Scope of mandatory and voluntary specifications in the railway sector

	Area	Specifications
Mandatory specifications	Noise	<ul style="list-style-type: none"> • Passing-by noise • Stationary noise • Starting noise
	Exhaust emissions	<ul style="list-style-type: none"> • Diesel exhaust emissions
	Materials	<ul style="list-style-type: none"> • Legally restricted materials
	Others	<ul style="list-style-type: none"> • Electromagnetic fields
Voluntary specifications	Materials	<ul style="list-style-type: none"> • Recycling rate • Renewable materials • Unwanted and controlled materials • Hazardous waste
	Others	<ul style="list-style-type: none"> • Emissions from brake friction material • Spillage/ leakages
	Energy	<ul style="list-style-type: none"> • Specific mass • Traction energy consumption • On-board energy consumption • Energy recovery/ regeneration • Energy management for parked vehicles • Energy metering devices
	Exhaust emissions	<ul style="list-style-type: none"> • Diesel exhaust emissions – specific load conditions • Diesel exhaust emissions at longer standstills

Source: “Recycling Guidelines of the Rolling Stock”, [MG, 2014]

In Europe, the most valuable initiatives in the direction of voluntarily introducing standards for regulating the recycling on rolling stocks has been promoted by the Association of the European Rail Industry (UNIFE), which defined unified guidelines for rolling stock recycling. In a participative process involving a broad panel of representatives of the railway sector supply chain, the UNIFE initiative developed the product category rules (PCR) for rail vehicles [EPD-PCR, 2009] which sets the life cycle system boundary and the rules to be considered in product specification for the three main processes related to rolling stock life cycle management (see Figure 58).

Figure 58 - General system boundary in the rolling stock PCR

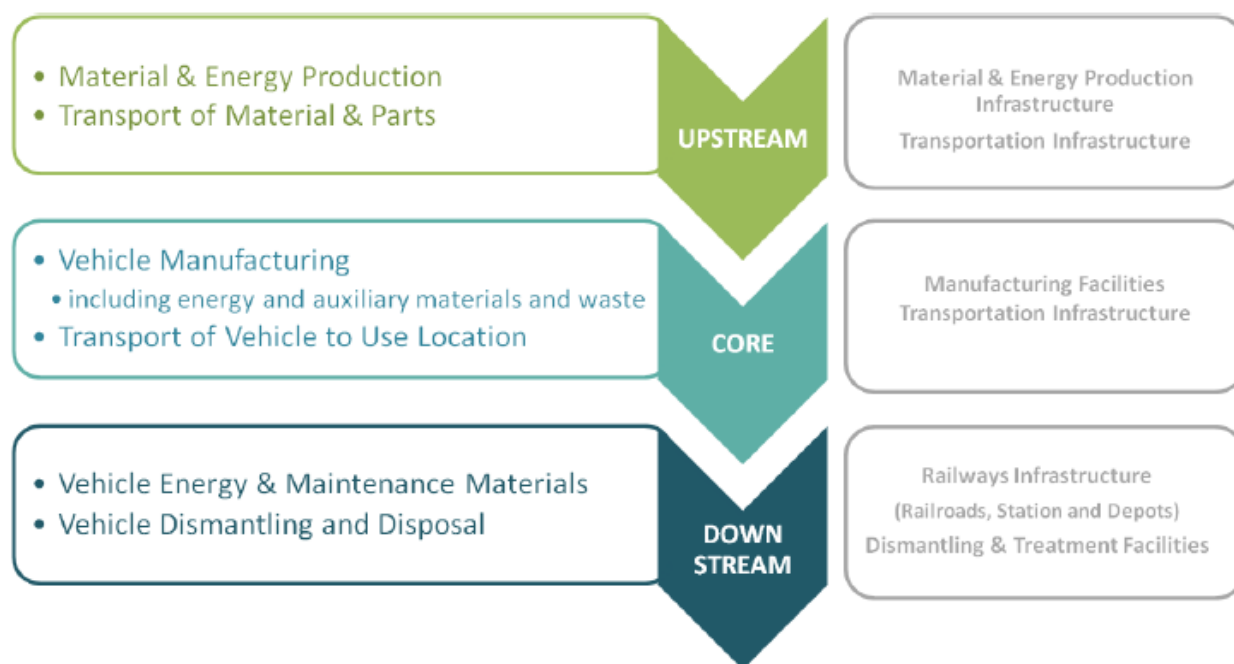

Source: “Product category rules (PCR) for preparing an environmental product declaration (EPD) for rail vehicles”, Version 2.11, 2014 [EPD-PCR, 2009].

The main reference for the development of the guidelines is the ISO-22628 standard for the automotive industry adapted to the specificity of the rolling stock. In addition, other applicable standards have also been used such as ISO-14040 and ISO-14044, both related to life cycle assessment. Since their publication, the PCR guidelines are adopted by rail vehicle manufacturers for the purpose of preparing the Environmental Product Declaration (EPD) according to the ISO-14025 standard, which constitutes a basis for the admission of the rolling stock to traffic in the EU.

To whom it concerns the downstream processes related to vehicle dismantling and disposal, the PCR refers to specific guidelines which have been developed by UNIFE in 2013 [UNIFE, 2013], which specify a methodology to calculate recycling and the recovery rates of components, materials and energy from end-of-life rolling stocks. Also in this case, the standard ISO-22628 for road vehicles has been taken as reference, but consistent modifications have been introduced in order to best fit the specificity of railways vehicles. Of course, methodology considers all possible options of recovery (components reuse, material recycling and energy recovery by incineration), but its reference to the rolling stock PCR within a life cycle approach can be considered as a turning point to strongly improve component reuse and material recyclability in place of energy recovery and disposal of to landfill, which should always be set as the less favourable option in the process.

According to the UNIFE guidelines, the process of recycling involves four main stages (Pre-treatment/Depollution; Dismantling, Shredding, Treatment of recovery materials) each involving several steps of treatment which can be summarized as in Figure 59.

In the pre-treatment, operating fluids as well as components and materials which can be harmful to human health and environment such as toxic and explosive substances or gases contained in brake systems, batteries, air conditioners etc. should be separated and collected by typology to be further treated at dedicated recycling facilities. In the following stage, all components which can be made available for reuse are dismantled along with other components such as windows, seats, floors, electric and electronic equipment ecc. which are addressed to further treatment and segregation for material recycling. The shredding stage refers to a dismantled vehicle and should be performed at well equipped facilities in order to separate, by different magnetic technologies, ferrous and non ferrous metals by kind (copper,

aluminium, zinc, ecc.). The non metal fraction is treated for further segregation of materials to be eventually recycled, or incinerated for energy recovery or landfilled.

Figure 59 - Scheme for treatment of end-of-life rolling stocks

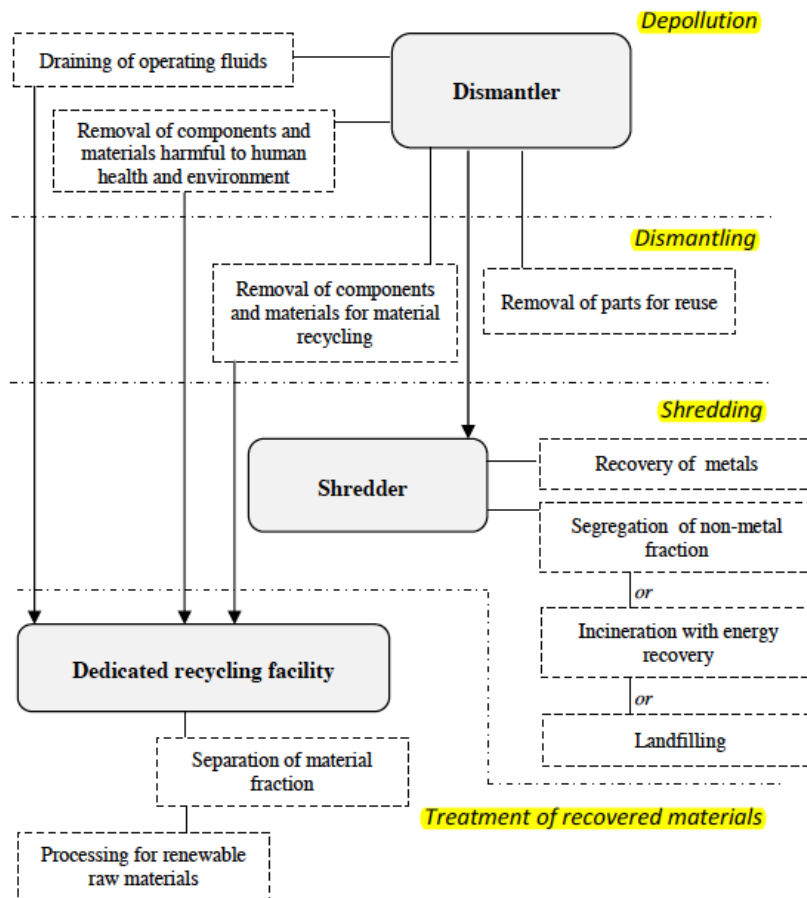

Source: "Recycling Guidelines of the Rolling Stock", [MG, 2014]

The recycling performances within this approach depends of several factors, including technological equipment and expertise available in each stage, and can be further improved by acting at product engineering. In particular, actions should be taken in the direction of improving the product design and the quality of the materials used according to the following priority actions:

- Reducing the range of material used for production
- Select materials with minimum or no content of substances hazardous for the environment and human health with preference to renewable materials
- Use easily recyclable materials, i.e. materials for which recovery technologies exists, and avoid composite materials that cannot be separated during the dismantling stage
- Label parts and subcomponents according to standards so that materials can be unequivocally identified
- Design the structure of the products in order to facilitate dismantling without deterioration of materials and components efficiency at minimum costs
- Increase durability and reliability of components

In Europe, in general, railway operators outsource the process of recovery end-of-life rolling stocks to

specialized operators according to technical specification based on UNIFE guidelines and due to the lack of EU regulation, there are no official statistics about recovery rates (material recycling + energy recovery).

According to data made available voluntarily by manufacturers and railway owners [MG-1, 2014], recovery performances range from 80% up to 95% of the total rolling stock weight, depending to the different type of rolling stock considered. Cargo railcars, for instance, are best performing and achieve very high level of material recycling due to their relatively simple design and material composition (they are made of steel and cast iron up to 80% of the total weight). On the contrary, passenger railcars achieve lower material recycling rate and performances are very different and related to their age (old railcars were not at all designed for efficient recycling at end-of-life) and typology (subway railcars have higher energy recovery rate due to presence of light composite polymers).

The new generation of railway vehicles optimized by design with reference to the rolling stock PCR, shows very high recoverability performances. The Environmental Product Declaration of new generation railcars produced by Bombardier, for examples, report a recoverability rate ranging from 95% to 98%, depending of the model (see Figure 60)

Figure 60 - Recyclability and recoverability performances of Bombardier new generation railcars

Vehicle	Recyclability	Recoverability	Year
OMNEO	92	95	2014
REGINA X55	93	98	2012
FLEXITY Outlook	92	98	2012
INNOVIA APM 300	95	98	2012
INNOVIA ART 200	93	96	2010
SPACIUM	93	98	2010
TALENT 2	92	96	2010

Source: “Applying EcoDesign guidelines when designing rolling stock in relation to recovery rates”, Bombardier official presentation at the 13th UIC Sustainability Conference, Vienna, 2016

Similarly, the Alstom manufacture declare that their new generation of railcars recoverability is on average of 98% of the total weight (see Figure 61).

Figure 61 - Recyclability and recoverability performances of Alstom new generation railcars

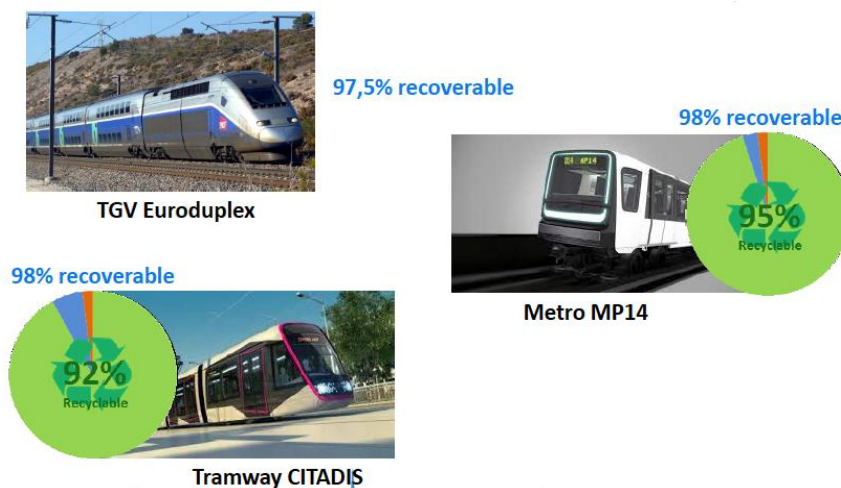

Source: “Recyclability of rolling stocks. Levers for recyclable trains”, Alstom official presentation at the 13th UIC Sustainability Conference, Vienna, 2016

Infrastructure recyclability

Due to the lack of EU regulation, there are no available statistics related to the recycling performances of railway infrastructure. According to interviews to railway operators, the rate of recovery (reuse and recycling) of components and materials contained in highly valuable electric and electronic equipment, as well as track, is close to 100% for metals and very low for other materials such as the plastics. To whom it concerns the ground structural parts, and in particular those realized in concrete, as well as the sieve of the ballast and the sleepers, the situation can vary depending of technical factors related to the quality and the kind of component as well of economic factors related to the convenience of recycling with respect to disposal of in landfill.

Railway infrastructures, have been subject of attention in several life cycle assessment studies [UIC-CF, 2011], in the frame of completing the carbon footprint evaluation of the rail transport mode. In these studies, the management of end-of-life components is only partially included in the system boundaries (in general electric and electronic components and the tracks are considered), with recycling coefficients based on specific experiences and reference treatment processes referring to inventory databases. In this respect, in order to be more consistent in reporting reliable information, a specific study should be addressed.

3.5.2 Challenges and limitations

Rolling stock recyclability

European manufacturers, have taken actions aiming at preparing the rolling stock for waste management, recycling, anticipating the future legal regulations and contributing to limiting the negative environmental impact of products throughout their life cycle. One of these actions has been the implementation of production standards aimed at guarantee the maximum possible rate of recovery already on the stage of design and production.

However, the low interest of the administration to define a comprehensive EU regulation for the railway sector, due to the small number of end-of-life vehicles of rail transport mode as compared to road passenger vehicles, still allows railway operators to approach end-of-life rolling stock management in a variety of different approaches.

In this respect, one of the main challenge related to rolling stocks recycling concerns the opportunity of introducing an EU standard recognized methodology for calculating the rate of recovery (recycling + energy

recovery) of components and materials of rail vehicles linked to a regulation with mandatory recycling targets. This goal can be achieved within several different approaches. Among the others, according to the need of improving circularity in the sector and to the strong link between vehicle manufacturers and railway operators, the regulatory framework could be build with reference to the extended producer responsibility scheme.

In this respect, limitations could be related to the life cycle of rail vehicles (that may reach several decades) which can make the approach towards recycling difficult because it is hard to predict which materials currently used in production may be banned in the future years, which will make them unrecyclable as materials and impossible to reuse. Furthermore, there is the need to combine the recycling requirements with other environmental requirements for the sector, such as the reduction of the CO₂ emission in operations (hence lower energy consumption). This might force manufactures to use lighter materials in the production of vehicles which might make recycling more energy (and resource) intensive, if not impossible due to technological limits.

Infrastructure recyclability

Same as for rolling stock, also for infrastructure recyclability one of the main challenge is related to the introduction of a comprehensive EU regulations, inclusive of mandatory targets, so to stimulate the railway sector to optimize infrastructure buildings by developing more efficient component solutions that enable to increase the infrastructure performances and lifetime.

In this field, one of the most valuable examples concerns the recently developed concept for new railway sleepers, namely the Greenrail sleepers (see Box below), which in addition to be made by recycled materials and to be fully recyclable at end-of-life, show a longer lifetime and better operation performances with respect traditional concrete sleepers, and contribute to reduce the ballast stress in operations, increasing its lifetime as well.

Box - Greenrail Sustainable Railway Sleepers

The Greenrail™ sleeper consists of an outer shell, made of a mixture of rubber obtained from end-of-life tyres and recycled plastic, and an inner structure in reinforced concrete. The life cycle of the Greenrail™ sleeper is estimated at more than 50 years starting from the initial installation. The outer shell in recycled material (plastic and rubber) ensures resistance to atmospheric agents, resistance to freezing/thawing and fire and helps reduce vibrations and noise, ensuring greater interaction between the sleeper and the ballast, thereby reducing the side movement of the track.

The inner structure in pre-stressed reinforced concrete ensures that the sleeper has the weight and structural specifications to allow it to be used on any type of line, even high speed. Greenrail™ is the only composite sleeper in the world obtained from recycled materials that is designed to use the “W” rail connection system preassembled in the factory. The W-type system enables greater speed of assembly and the option of using the now common mechanized system for renewal or laying the tracks (so-called “renovator trains”) to lay the sleepers.



Figure 3: Greenrail sleeper (plan)



Figure 4: Greenrail sleeper (section)

With reference to the railway sleepers market, the technology patented by Greenrail S.r.l. combines the structural benefits of sleepers in reinforced concrete with the financial, durability and safety benefits of composite sleepers, making an objective contribution to the recycling of plastic and rubber waste.

The Greenrail™ was designed to enable its integration in an energy production system. Indeed, it is currently the only railway sleeper designed to produce electricity, both by means of a piezoelectric system (Greenrail Piezo) inside the sleeper – in the section under the track – which generates energy through the compression the track undergoes on the passing of a train, and by means of a photovoltaic module (Greenrail Solar) in the central part of the sleeper, capable of transforming every km of line into a photovoltaic array producing around 150 kw/h. The energy produced is also used to power the integrated systems inside the sleeper itself, which is able to transmit safety and telecommunications data (Greenrail Linkbox).

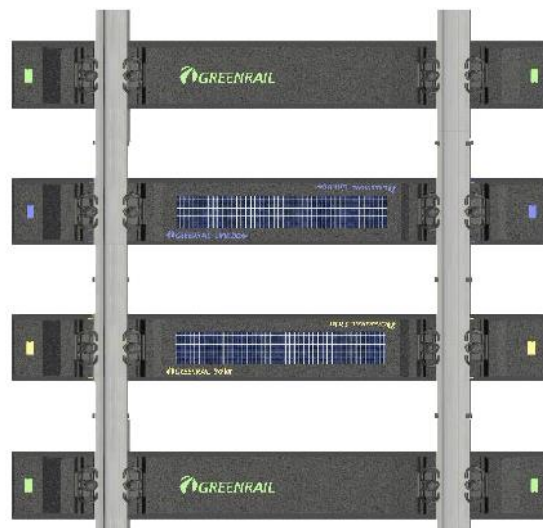

Greenrail™ therefore combines aspects of global innovation, offering to radically revolutionise the sector of railway sleepers. In some countries (USA, India, China), recycled plastic and rubber sleepers have been used for some time to replace obsolete wooden sleepers but - because of treatment with creosote oil – these sleepers are highly polluting, especially on disposal. The recycled rubber and plastic sleepers, today available in the market, due to technical defects, cannot be used as replacement for the concrete sleepers that have by now become standard for more than 70% of the world's railway lines.

The Greenrail™ sleeper, on the other hand, is the only sleeper obtained from recycled materials

that has sufficient weight and the safer track connection systems that are widely used in the world, enabling its use even on high speed lines faster than 250 km/h.

More information at www.greenrail.it

3.5.3 Recommendation

Due the strict relationship between recyclability and technological innovation, both in product design and new materials, one of the main recommendation concerns the importance for the railway sector to promote and sustain the research & development activities in related fields.

3.6 Land Use

In the rail sector, this topic deal with four subjects: Vegetation Control, Biodiversity, Soil Contamination and Land-take. For rail companies and infrastructure manager, in particular from the angle of environmental issues, the topic of vegetation control occupies a prominent place.

3.6.1 Current situation

The vegetation control for the railway sector is a safety concern. The objective of vegetation control is to keep railway track area plant-free as encroaching weeds can endanger the safe passage and braking of trains as well as functioning of control-command and signaling system.

For this purpose, UIC has drawn up the Leaflet 723 issued in January 1992 under the title "Selection and use of weedkillers alongside railway tracks from the standpoint of environmental protection", subsequently completely overhauled in 2004 on the basis of a UIC study named "*Herbizidauswahl und -Anwendung im Oberbau unter Berücksichtigung des Umweltschutzes*" completed in 2002.

The purpose of Leaflet 723 is to “offer guidance to railway infrastructure management and staff in addressing the issue of vegetation control on the railway; provide a short justification for the need to control vegetation; give an overview on different approaches used for vegetation control by railway companies, together with some basic information about vegetation control management systems”.

The Leaflet 723, offer a schematic representation of the areas for vegetation control (see Figure 62):

- AREA AB
 - *Ballast Bed*: part of the track-bed made of ballast or gravel including embedded sleepers and rails.
 - *Slab Track*: concrete track-bed construction.
- AREA C
 - *Transition Area*: part of the track abutting the slope on both sides of the ballast bed, includes walkway for maintenance/ inspection purposes and areas between two tracks (lines with 2 or more tracks). Drainage ditches are also built in Area C in some cases.
- AREA D
 - *Embankment*: the slopes alongside the track away from the track adjoining Area C

Figure 62 Schematic representation of the areas for vegetation control

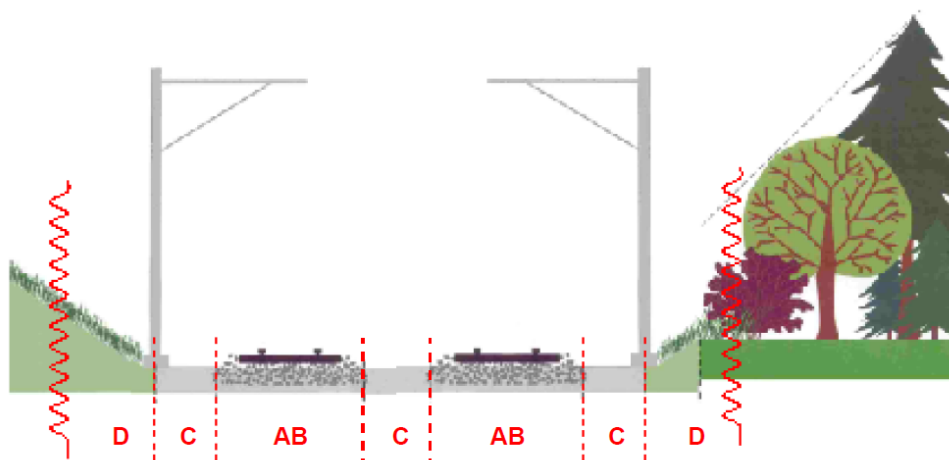

Source: UIC Leaflet 723

The leaflet, after identifying the areas covered by vegetation control, lists the reasons that underlie this core activity and what are the risks that must be averted.

The reasons are related to the following areas:

- Safety Reasons
 - Affect braking and starting power of trains, through loss of adhesion
 - Restrict sighting of ground signals (especially in rail yards) and level crossing
 - Reduce safety for railway workers
 - Close emergency routes
 - Increase risk of fire
- Operational and Technical Reasons
 - Have an influence on track quality (e.g decrease elasticity of ballast bed) which can have safety impacts
 - Impair resistance to frost (by reducing drainage efficiency of ballast bed)
 - Weaken sub-layers and enable material to be pumped up to the surface (thereby impairing drainage)
 - Affect electrical signal systems along the track (by increasing humidity and thus electrical conductivity)
 - Carry out maintenance and survey on track components : Ballast, sleepers, rails, fastening system and allow optical measurement of track geometry
- Economic Reasons
 - Deterioration in quality and performance of ballast (e.g. by binding in fines and pollutants)
 - Reduced hardware lifespan due to increased track-level humidity (e.g. rusting of metal fastenings, accelerated decay of wooden sleepers)
 - Increased track stability maintenance cycle (e.g. by weakening sub-layers)
 - Shortened cleaning intervals (necessary to purge ballast of fines and pollutants)

The aim of vegetation control in the different areas is to keep the track (Areas AB and C) free of vegetation and to keep vegetation on the embankment (Area D) within certain limits. To achieve these objectives, the measures and apply the methods normally used in the construction phase and as maintenance activities.

A table of Leaflet 723 shows an overview over different engineering methods (see Table 8).

Table 8 Overview of construction and re-construction methods

Method	Application area	Effects on plants	Examples
Lateral plant barriers/ objects impeding plant incursion	C, D	Prevents plants from growing into Area C and from there into Areas AB - not effective against plants growing in from the sub-ground	Suitably positioned cable troughs or noise barriers
Plant barriers beneath the track in general	AB, C	Prevents plants from growing up from below, additional benefit for drainage	Layer of bitumen or concrete, sheets,
Slab track	AB	Plant barriers beneath the track prevent plants from growing up from below	
Planting (with less problematic plants)	D	Competition of plants prevent the growth of undesirable species	Strongly competitive plants

Source: UIC Leaflet 723

There are different methods of vegetation control in the maintenance process applied within the track and those applied on the embankment. Chemical methods are predominantly used in the track and non-chemical methods in the embankment.

Within the track (Areas AB and C) the current maintenance methods fall into three different groups:

- Commonly applied maintenance methods
- Non-chemical methods
- Chemical methods.

Chemical methods are the most effective and cheapest maintenance methods. They are easy and fast enough to apply even if they need well-trained operators for safe use and the risks of impacts on the environment must be avoided by careful planning.

Table 9 Overview of methods used in maintenance within the track (areas AB and C) in Leaflet 723¹³

Method	Application area	Costs (€ / km) ^a	Operating speed	Duration/ frequency of application
Ballast cleaning/ replacement	AB, C	5 100 - 350 000	Up to 200 m/h	
Manual weeding	AB, C	315 - 4 000 (0,04 - 2 €/m ²) ^b	9 - 105 m ² /h	1 to 4 times a year
Back-pack spraying (herbicides)	AB, C, D	5 - 850 ^b	Up to 5 km/h 150 - 4 750 m ² /h	Depending on herbicide used, half a year up to 2 years
Spraying train (herbicides)	AB, C, D	34 - 260 (0,01-2,5 €/m ²) ^b	Up to > 40 km/h 12 550 m ² /h - 400 000 m ² /h	
Herbicide application with rail-road vehicle	AB, C, D	196 - 300 (2 €/m ²) ^b	Up to 40 km/h 10 000 m ² /h - 50 000 m ² /h	
Selective application of leaf herbicides with spraying train ^c	AB, C	260 ^b	Up to 40 km/h up to 260 000 m ² /h	

Source: UIC Leaflet 723

The purpose of the chemical treatments is to eradicate all vegetation in the ballast structures and on the tracks. The means of application of the treatment are normally:

- Weed-killing Trains (TDGR) in with different levels of efficiency as a function of the technologies adopted to control and to dose the application of the treatment used on the railway lines
- Weeding trucks used for treating areas around level crossings, station yards, approaches to depots, etc.

3.6.2 Challenges and limitations

The railways are recognized as one of the most sustainable modes of transport. This reputation must be constantly maintained, not only as an ethical imperative, through a continuous improvement of environmental performance.

¹³ a) Comparing costs is very difficult because of varieties within one method and different wage levels in different countries, as well as different cost compilation methods. Costs per application referred to the Leaflet date of issue. b) When used on both sides of the track c)

On vegetation control, railways face a big challenge: to guarantee the safety of the tracks and signalling equipment whilst taking into account the question of environmental and health protection, which corresponds to railway sector environmental responsibility. In this context, the European railway sector is constantly looking for methods less polluting, more and more selective and efficient to ensure safety with less and less use of pesticides. For example, the “Rail Technical Strategy Europe” plan to reduce pollution from rail sources as chemical treatment against vegetation.

The challenge for the railways in this area is to develop and, at the same time, to demonstrate to stakeholder, policy maker and public opinion a responsible use of herbicides. This main goal should be achieved avoiding an increase in the cost of vegetation management. In other words, every measure have to be cost effective.

The EU has one of the strictest regulatory systems in the world concerning the approval of pesticides. All pesticides on the market have been subject to a thorough assessment to ensure a high level of protection of both human and animal health and the environment. The Framework Directive on the Sustainable Use of Pesticides (2009/128/EC) banned the use of 22 pesticide ingredients aiming to reduce risks and impacts of the use of pesticides on human health and on the environment. The Directive promote furthermore the use of integrated pest management and the use of alternative techniques. The Pesticides Authorisation Regulation, which came into effect in June 2011, tightened controls further.

Glyphosate is one of the most widely used broad-spectrum herbicides around the globe. The major application for glyphosate products is agriculture, but it is also used to control unwanted weeds along railway tracks. Numerous health assessments conducted by public authorities over the past 40 years have consistently concluded that glyphosate does not pose any unacceptable risk to human health. However, a controversial debate concerning the assessment of glyphosate health risks has emerged, largely as a result of a recent publication entitled “Roundup And Birth Defects: Is the Public Being Kept in the Dark?” released by the non-governmental organisation Earth Open Source. The report expresses criticisms of a number of toxicological evaluations and risk assessments conducted by official authorities in recent decades. In particular, it refers to some studies that reported developmental toxicity in in vitro tests with isolated chicken and frog embryos and human cell lines.

Active substances, as Glyphosate, in the pesticides have to be approved at EU level. The EU approval of an active substance means that the Member States can authorise plant protection products on their territory, but they are not obliged to do that. Nonetheless, if there is no EU approval, Member States have no choice. Once an active substance has been approved or renewed at EU level, the safety evaluation of every pesticide (also referred to as Plant Protection Products PPPs) formulation is done at a later stage by individual Member States before they grant, refuse or restrict – the use of pesticides formulations at national level. The EU approval of an active substance is only granted for a limited period of time (up to 15 years) and must be renewed regularly. As regards glyphosate, it had been under evaluation, since 2012, for a possible renewal of the approval, following the procedures laid down in EU legislation on plant protection products (PPPs).

The Commission adopted in June 2016 the extension of the current approval of glyphosate for a limited period until the European Chemical Agency (ECHA) has concluded its review - since Member States failed to take responsibility (no qualified majority was reached at either the Standing Committee or the Appeal Committee). In parallel to the extension of the approval, the Commission has already presented to Member States a series of recommendations on the use of glyphosate. The decision will contain three clear recommendations:

- ban a co-formulant called POE-tallowamine from glyphosate based products;
- minimise the use of the substance in public parks, public playgrounds and gardens;
- minimise the pre-harvest use of glyphosate.

The European rail sector in a Position Paper of Community of European Railway (CER) and European Rail Infrastructure Managers (EIM) in 2016 consider “a full prohibition of any kind of usage of herbicides along any kind of railway infrastructure is not feasible at the moment”. The non re-registration of glyphosate

means for European railway companies the complete cessation of weeding on the tracks and pathways, which will have major impacts on the safety of railway traffic and staff, disrupting the financial equilibrium of the railway system.

According to CER/EIM Position Paper “the existing non-chemical methods to control vegetation alongside railway lines can only be used in a very limited number of cases, due to their technical and operational parameters. Unfortunately, there is no other method available able to replace chemical methods at the moment”.

Railways have studied non-chemical curative methods like thermal weeding (direct flame, infra-red, steam, hot water and hot foam) and mechanical weeding. The principle of thermal method is to generate an intense wave of heat that ruptures plant cells. The distribution of energy into the plant is limited, thus only destroying the aerial part of the plant or the youngest annual plants (seeding stage). Perennial and annual plants regenerate rapidly and therefore require numerous treatments per year in order to be killed off. The treatment of rampant weeds and grasses is difficult, and potentially ineffective. Treatment rates are slow and the risk of fires is high. Developments of steam, hot water and infrared trains have not proved positive and have been abandoned. The operational assessments revealed a huge consumption of water and of fuel, a track occupancy incompatible with rail operation (forward speed from 1 to 2 km/h) and the start of combustion of wooden sleepers and undersleeper rubber pads.

The environmental impact of these techniques diminishes their advantage on an LCA view. According to a recent study adopted by SNCF based on the total LCA scores, chemical weed control methods using glyphosate have a much lower impact on the environment than non-chemical methods. The results of this study were confirmed by the COMPAMED ZNA program (Comparison of weeding methods in non-agricultural areas), the conclusions of which are shown below:

- Hot Water, Steam and Flame methods have the highest impact on all of environmental indicators, except on ‘aquatic ecotoxicity’.
- Overall, Hot Water has the highest negative impact of all the methods studied, especially on impermeable surface.
- Chemical methods have the highest impact on ‘aquatic ecotoxicity’ but using optical detection sprayer rather than other chemical methods limits environmental impact.

Figure 63 LCA of weed control methods

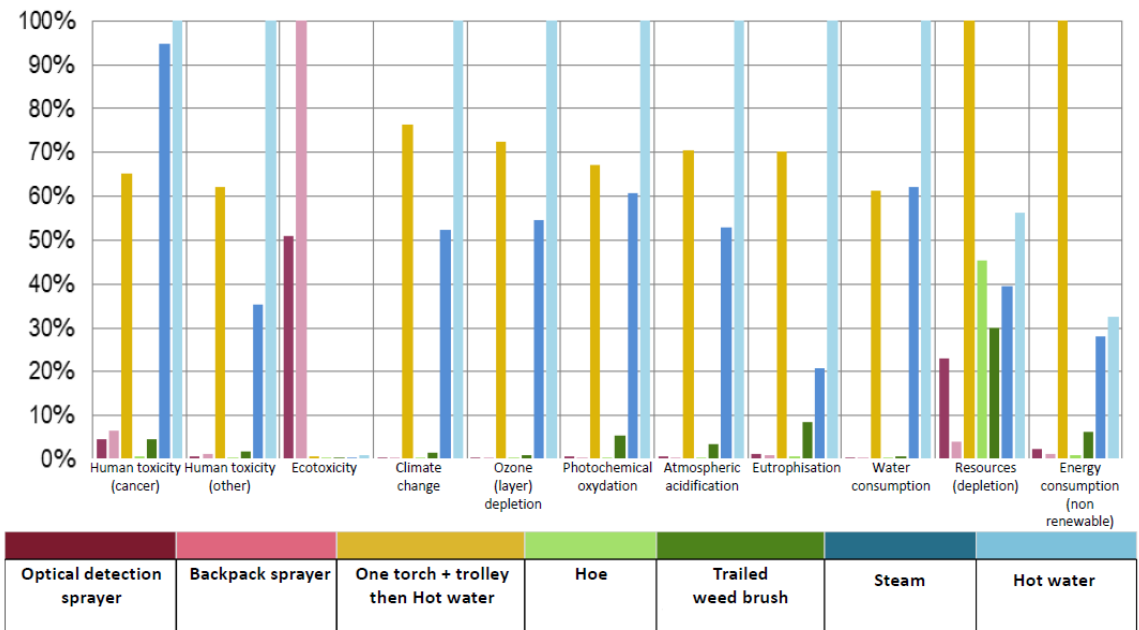

Source: ECOPHYTO - PROJECT ZNA (non-agricultural area)

Overall, mechanical methods have low impact, but these techniques for “weed picking” proceed at a slow speed similar to thermal methods and are very labour intensive. Track closures are required for the application of mechanical techniques, which would disrupt rail services. The labour-intensity of this method translates into an increase in costs. Most important of all, mechanical methods are insufficient to remove the plant roots. Plants removed could therefore grow again quickly. Because of these reasons, mechanical methods are used in combination with other methods.

Hand weeding (Hoe) is the method with the lowest impact but manual removal would not be possible on all railway tracks. Apart from the work force required, it is a dangerous operation. The safety of railway workers would no longer be ensured in the long run, calling into question the possibility of maintenance operations.

Responsible composition of conflicting requirements such as safety of rail traffic and the environment is necessary not only because it raises awareness of the possible damage to the environment and to human health but also because it is necessary to further reduce the risk of rail accidents due to falling branches and tree trunks on the railway line. The vegetation control must take into account also this topic that has relevance not only for the environment but also for landscape.

The ongoing process of UIC Standardization carried out with the IRS 90001 includes clearly in the scope of action of the vegetation control the tree risk management.

3.6.3 Recommendation

The vegetation control on railway networks need an extremely high standard management improving spraying methods and technical equipment, application and reduced concentration, monitoring and documentation (GIS, digital data and remote control).

UIC leaflet 723 Vegetation Control will be updated into the New IRS 900001 “Technical aspects of vegetation and tree risk management” and it will provide guidance and recommendations. In this paragraph, dedicated to the recommendations, a summary of the main issues addressed in the new IRS is provided.

The new IRS cover the following aspect:

- The need for vegetation control
- Methods for recording and assessing vegetation
- Use of design and engineering to exclude vegetation
- Control by use of herbicides
- Mechanical management: comparison of methods
- Tree risk assessment and control
- Leaf-fall management
- Management and use of arisings
- Biodiversity action plan design for lineside habitat

Vegetation inventory and assessment

Compared to Leaflet 723 the new IRS give more attention to the Vegetation inventory and assessment phase. A good knowledge of the plant life along the railway corridor can reduce waste and the need for chemical treatments, whilst also improving network efficiency facilitate targeted management and pre-planned, proactive intervention.

To facilitate, increase and reduce the cost of inventory of inventory and assessment activities, airborne remote sensing can be used to facilitate computer-based, automated, data extraction and analysis useful to:

- Identify locations requiring intervention under a wide variety of headings

- Output management constraints, for example slope angle adjacent to railway preventing use of certain mechanical management systems.
- Highlight ecologically sensitive areas, such as nearby aquatic habitats.

These types of output enable vegetation managers to select the optimum control methods at constrained locations.

Remote sensing should include data capture by LiDAR and hyperspectral camera. This allows differentiation between surface vegetation and terrain/ ballast, as well as an assessment of plant vitality through infra-red imaging (where data capture occurs during the plant growth season).

Figure 64 Infra-red imaging

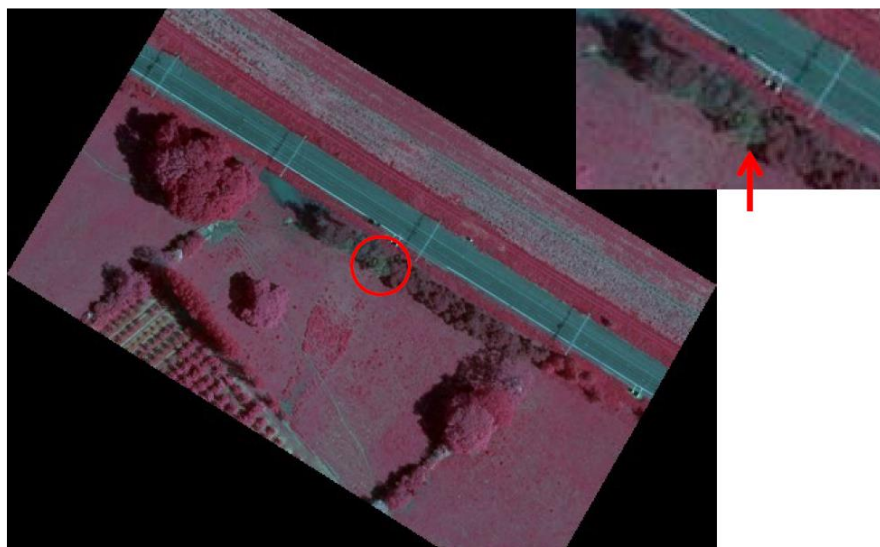

Source: J. Forbes-Laird based on <http://www.flac.uk.com/>

Vegetation exclusion by engineering and design

New IRS shows an overview of current engineering methods (see Table 8) applied to railway construction and renewal to create an unfavourable environment for plant colonization. Even if these techniques remains costly, being pesticide-free, design and engineering controls can be necessary particularly in ground-water protection areas, and/ or at other locations where the use of pesticides is restricted. For these reasons, these methods must be integrated on a wide vegetation management system.

Table 10 Overview of construction and re-construction methods

Method	Application area	Effects on plants	Examples
Lateral plant barriers/ objects impeding plant incursion	C, D	Prevents plants from growing into Area C and from there into Areas A/B - not effective against plants growing in from the sub-ground	Suitably positioned cable troughs or noise barriers
Plant barriers beneath the track in general	A/B, C	Prevents plants from growing up from below, additional benefit for drainage	Layer of bitumen or concrete, geotextile sheets,
Slab track	A/B	Monolithic construction of track prevents plants from growing up from below and reduces opportunities for colonisation from Area C or from windblown seed	
Planting (with less problematic plants)	D	Competition of plants prevent the growth of undesirable species	Strongly competitive plants

Source: UIC

Other control methods within the railway corridor

In the Area A (ballast-type track-bed), the only alternative to pesticide application is high-temperature biodegradable foam but. This is difficultly applicable on a large-scale due to its high cost.

In the Area B (slab-type track-bed) the only alternative to pesticide application is high-pressure air blasting offering potential for low cost, high sustainability and zero residue.

In the Area C the IRS do not provide other methods then pesticide application.

In the Area D methods recommended varies from pesticide application (where this can be applied selectively without significant adverse impacts on lineside habitat) to mowing.

Vegetation management by pesticide application

The new IRS supports and promotes the ongoing use of herbicide, for which there is no currently viable alternative. The IRS includes detailed information on the range of 24 pesticides used by 29 UIC Members. IRS recommend to undertake a review of the pesticides used and to work with UIC to standardize the collective of treatments into a more coherent list.

Many of the pesticides currently reported have the potential for adverse effects if applied incorrectly. For this reason railway companies must develop and maintain “robust procedures to ensure correct application in accordance both with the manufacturers’ recommendations, and with the locally prevailing regulatory framework”.

As noted before a responsible usage of pesticide claim for:

Proper planning of treatments, including: location and type of treatment required, timing, weather conditions, area to be treated, method and rate of application;

- A clear understanding of the limitations and constraints of the pesticides concerned;
- Advance notification of local government, licensing bodies and adjacent landowners;
- Operator safety during the application process;
- Targeting of treatments (for example, by automatic plant recognition dispensing system), so as to minimise chemical use and waste;
- Prevention of wind-drift or run-off into non-treatment areas, especially here outside the railway corridor and/ or ecological sensitivity;
- Monitoring and record keeping of all aspects of each treatment, including total volume administered;
- Follow-up effectiveness and adverse impact assessment, and subsequent lesson-learning for future treatments.

Mechanical management

Within the line side (Area D) the use of mechanical management is recommended and strictly related to the nature of the vegetation. A comparative assessment of differing methods for mechanical management is provided with information on slope angle limitations, and tasks for which the various methods are unsuitable.

The safety of personnel employed in the mechanical management operations is a paramount issue.

Tree risk management

Tree risk management must avoid the following risks:

- Derailment risk
- Operational risk
- Environmental risk

An effective tree risk management is a result of a combined approach based on incidental observation of tree defects by trained railway staff, supported by specialists where required, and on the use of remote sensing ¹⁴ , can provide an enhanced level of safety and network storm resilience.

¹⁴ Information given about remote sensing as a vegetation management tool for inventory and assessment is equally applicable to tree risk control. A LiDAR measured survey of the railway corridor can be used to derive a tree risk assessment and control system, to manage both derailment and operational risks

3.7 Railway environment management

3.7.1 Green procurement: UIC Leaflet 345

3.7.1.1 Background

When you buy a product, service or work, you always pay a price. Purchase price, however, is just one of the cost elements in the whole process of procuring, owning and disposing.

Life-cycle costing (LCC) means considering all the costs that will be incurred during the lifetime of the product, work or service:

- Purchase price and all associated costs (delivery, installation, insurance, etc.)
- Operating costs, including energy, fuel, spares, and maintenance
- End-of-life costs, such as decommissioning or disposal

LCC may also include the cost of externalities, such as greenhouse gas emissions.

LCC makes good sense regardless of a public authority's environmental objectives. By applying LCC you will take into account the costs of resource use, maintenance and disposal which are not reflected in the purchase price. Often this will lead to 'win-win' situations whereby a greener product, work or service is also cheaper overall.

The main potential for savings over the life-cycle of a good, work or service are outlined below.

Savings on use of energy - The costs of energy during use often make up a significant proportion of the total cost of owning a product, work or service, and of its life-cycle environmental impact. Reducing this consumption makes clear sense both financially and environmentally.

Savings on maintenance and replacement - In some cases the greenest alternative will be one which is designed to maximise the period until replacement and/or minimise the amount of maintenance work which needs to be done. The most sustainable option may be one which helps to avoid such costs, and this can be assessed as part of LCC.

Savings on disposal costs - Disposal costs are easily forgotten when procuring a product or tendering for a construction project. Costs of disposal will eventually have to be paid, although sometimes with a longer delay. Not taking these costs into account when you buy can turn a bargain into an expensive purchase. Disposal costs range from the cost of physical removal to paying for secure disposal. Frequently, disposal is governed by strict regulations, such as those in place under the WEEE Directive. In certain cases, there may be a positive return to the owner at the end of life, for example where vehicles or equipment can be sold on or recycled profitably.

An increasing number of public authorities in Europe are using LCC to evaluate tenders, and a variety of tools of different complexity and scope have been developed.

3.7.1.2 Summary of UIC Leaflet 345

Buying railway rolling stock is a very complex affair due to all the technical, operational and safety requirements existing within national and EU regulation. Concern for relevant environment and energy matters are often forgotten, neglected or deemed of limited importance.

The leaflet 345 'Environmental Specifications for new rolling stock' defines environmental specifications recommended to use in the tendering process.

The systemic and general aims of the Leaflet 345 is to harmonise the environmental procurement framework in the rail sector at European, and in the long-term global level. It is aimed at all players in the rail sector interested in integrating environmental issues into the procurement process.

The leaflet is designed to provide assistance for the purchase of new rolling stock for freight transport and passenger transport (multiple units, locomotives, wagons and carriages).

In particular, the Leaflet intends to:

- prioritise environmental aspects for rail vehicles
- integrate environmental specifications in invitations to tender in a consistent manner
- evaluate tenders in terms of meeting environmental requirements

The Leaflet 345 adopts a **functional approach using environmental specifications related to performances** and not predefined technical solutions. In environmental impact assessment, the approach to the whole life cycle of the rolling stock is recommended. In this regard, the recommendations of the Leaflet 345 aim to improve the environmental performance focusing on the most crucial issues in the whole life cycle. An approach to the evaluation of tenders should integrate assessment of the environmental as well as the economic performance with respect to Life-Cycle-Costs (LCC).

The target audience for this leaflet is users within the rail business who are involved in the procurement of new rolling stock (assisting operators, engineering and purchasing staff of manufacturers) and environmental experts.

The economic effects of specific measures to improve environmental performance depend from

- the framework conditions of the relevant key area (legislation, regulations, policy, standards etc.);
- the technologies used (technological potential, degree of innovation, maturity, availability, market size).

From the economic point of view, the improvement of environmental performance in non-regulated areas must take place on favorable terms for railways in order to guarantee the competitive advantages in the transport market. A complete and accurate analysis of economic effects should not focus only on initial investment costs but it should be based on a LCC perspective.

Specific environmental performance contributes to minimisation of operational costs. Reducing energy consumption for example is a clear and well-recognised benefit, especially in view of the mid and long-term increase in energy supply prices.

The future developments in the legal, political and technological framework conditions and the long life-span of rail vehicles calls for a long-term risk/opportunity perspective in the rolling stock procurement. A change in the legal framework could pose severe business risks for railways in terms of potential upgrading of existing fleet and specific environmental performance compliance in tenders for service contracts.

3.7.1.3 Environmental specifications in invitations to tender

Environment specification: key area, types, degree of quantification, description

The core of the UIC leaflet 345 is a set of harmonised environmental specifications in the four environmental key areas Energy Efficiency, Materials/ Recycling/ Waste, Noise and Exhaust Emissions.

Figure 65 Key environmental areas

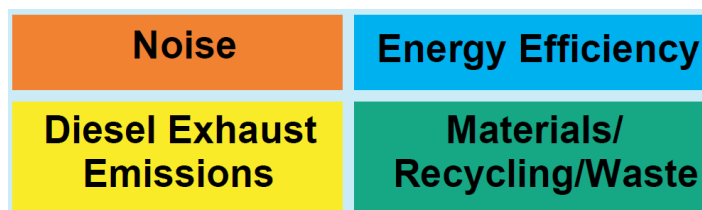

Source: UIC 2006

The following general strategic orientations can be attributed to the different types of specifications. It differentiates between mandatory and voluntary specifications. The **Legally Mandatory Specifications** are legally regulated. A potential better performance than the legal baseline could represent a more sound long-term investment in rolling stock because it reduces the risk of future expenses and efforts to meet higher environmental legal standards. The **Voluntary Specifications** are not governed by legislation. These

specifications can be used in invitations to tender according to the environmental strategy of the company, national requirements and priorities as well as economic assessments.

Target values for the mandatory specifications are defined by legislation/regulations and therefore must be met by any tenderer. However, compliance with the applicable legislation is only the minimum requirement and in general, a better environmental performance will yield better evaluation results from the environmental point of view.

The **Voluntary Specifications** follows two groups: environmental performance mainly dependent *on design* or *on operation*. The **performance mainly dependent on design** have a direct influence on the environmental performance of rolling stock basically independent of its operation. As examples the rate of renewable materials and the specific mass are fixed by construction and do not change during the lifetime of the vehicle unless design changes are made to the vehicle. The **performance mainly dependent on operation** depends to a high degree on how the new rolling stock is used in operation. The design is certainly a precondition to obtaining a good performance. However, whether or not it is reached in practice depends largely on operational patterns and the infrastructure on which the rolling stock is used. Energy meters for example will not yield any reduction in energy consumption by themselves, but are a prerequisite for energy efficient driving campaigns with which energy consumption can be reduced dramatically.

The table below lists the environmental specifications, which are defined and described in detail in the Leaflet 345.

Figure 66 Overview of all specifications

	Performance mainly dependent on design		Performance mainly dependent on operation	
	key area	Specification	key area	Specification
Legally mandatory specifications	Noise	Passing-by noise	not applicable	not applicable
		Stationary noise		
		Starting noise		
	Diesel exhaust emissions	Diesel exhaust emissions		
	Materials	Legally restricted		
Others	Electromagnetic fields			
Voluntary specifications	Energy	Specific mass	Energy	Traction energy consumption
	Materials	Unwanted and controlled materials		On-board energy consumption
		Hazardous waste		Energy recovery/regeneration
		Recycling rate		Energy management for parked vehicles
		Renewable materials		Energy metering devices
		Others		Emissions from brake friction material
	Spillage/ leakages		Diesel exhaust emissions at longer standstill	

Source: UIC 2006

Depending on the extent to which specifications are quantifiable, the following four categories can be assigned to environmental specifications:

- Design provision
- Compliance specification
- Performance specification
- Target specification

Design provisions are qualitative environmental specifications, which describe special equipment or component with a specific function (e.g. provision of rolling stock with energy meters). The manufacturer should provide technical information relating to the special equipment detailing its performance (example: energy metering devices).

Compliance specifications are environmental specifications not to be quantified focusing on compliance with existing legislation or standards. The manufacturer must simply state whether or not the rolling stock or certain components conform to the required legislation/standard (example: spillage/leakage).

Performance specifications are environmental specifications to be quantified by the manufacturer for which no target values are set. Instead, the manufacturer is asked to specify a certain performance value to be calculated or measured under defined conditions.

Target specifications are environmental specifications to be quantified by the manufacturer for which target values are set. These are directly taken from the applicable legislation/ regulations/ standards. Alternatively, they can be developed within the framework of a consensus process between operators and manufacturers.

Figure 67 Quantification process

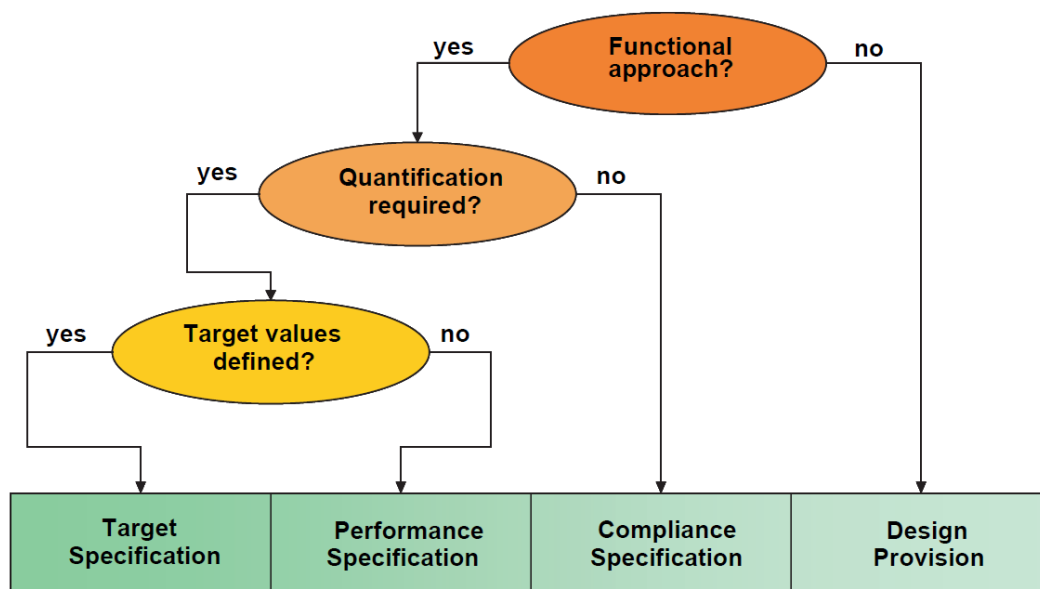

Source: UIC 2006

The Environmental Specifications recommended for use in invitations to tender are listed according to the following scheme:

- Key Area
- Title of specification
- Introduction
- Definition
- Environmental performance indicator
- Target value (for Target Specifications only)
- Application (Multiple units, Locomotives, Passenger coaches, Freight wagons)
- Type of specification (Mandatory/Voluntary, Environmental performance defined by operation/ by design)
- Degree of quantification (Target specification, Performance specification, Compliance specification, Design provision)

In the Leaflet 345 target values are given for those specifications for which they could be derived from the applicable legislation. For all other quantifiable and measurable specifications no values are defined. Operators should set requirements for performance values in order to assess the environmental performance of new rolling stock.

The question of who sets the requirements for the environmental performance of rolling stock is not always easy to answer and differs from country to country and company to company. In addition to legal requirements and requirements voluntarily set by the railway operator, additional requirements may be set by infrastructure operators or national authorities, which put transport services out to tender such as regional rail transport. These additional requirements must also be taken into account in the procurement process.

Table 11 Overview of all specifications

N°	Key area	Environment specification	Application				Type of specification				Environmental performance indicator	Degree of quantification			
			Multiple units	Locomotives	Passenger coaches	Freight wagons	All types of rolling stock	Mainly dependent on Design	Mainly dependent on Operation	Mainly dependent on Design		Mainly dependent on Operation	Target	Performance	Compliance
1	Energy	Traction energy consumption	x	x							x				
2	Energy	On-board energy consumption			x							x			
3	Energy	Energy recovery/regeneration	x	x										x	
4	Energy	Energy management for parked vehicles	x		x									x	
5	Energy	Energy metering devices	x	x										x	
6	Energy	Specific mass								x				x	
7	Noise	Passing-by noise												x	
8	Noise	Stationary noise												x	
9	Noise	Starting noise	x	x										x	
10	Diesel exhaust emissions	Diesel exhaust emissions	x	x										x	
11	Diesel exhaust emissions	Diesel exhaust emissions in specific load conditions	x	x										x	
12	Diesel exhaust emissions	Diesel exhaust emissions at longer standstill	x	x										x	
13	Materials	Legally restricted												x	
14	Materials	Unwanted and controlled materials												x	
15	Materials	Hazardous waste												x	
16	Materials	Recycling rate												x	
17	Materials	Renewable materials	x		x									x	
18	Others	Electromagnetic fields												x	
19	Others	Emissions from brake friction material												x	
20	Others	Spillage/ leakages												x	

Source: Elaboration by SUSDEF

The Leaflet 345 proposes a procedure for the procurement process (highly simplified) and a method for integrating environmental aspects into the procurement process. The leaflet describe the procedure that have to be implemented by different railway companies to integrate environment aspects into the rolling stock procurement process, listing:

- the steps needed
- the categories of experts that must be involved
- the tasks that have to be performed
- the input needed to carry out these tasks
- the output of every step of the procedure

Figure 68 Procedure for the integration of environmental aspects into the railway procurement process

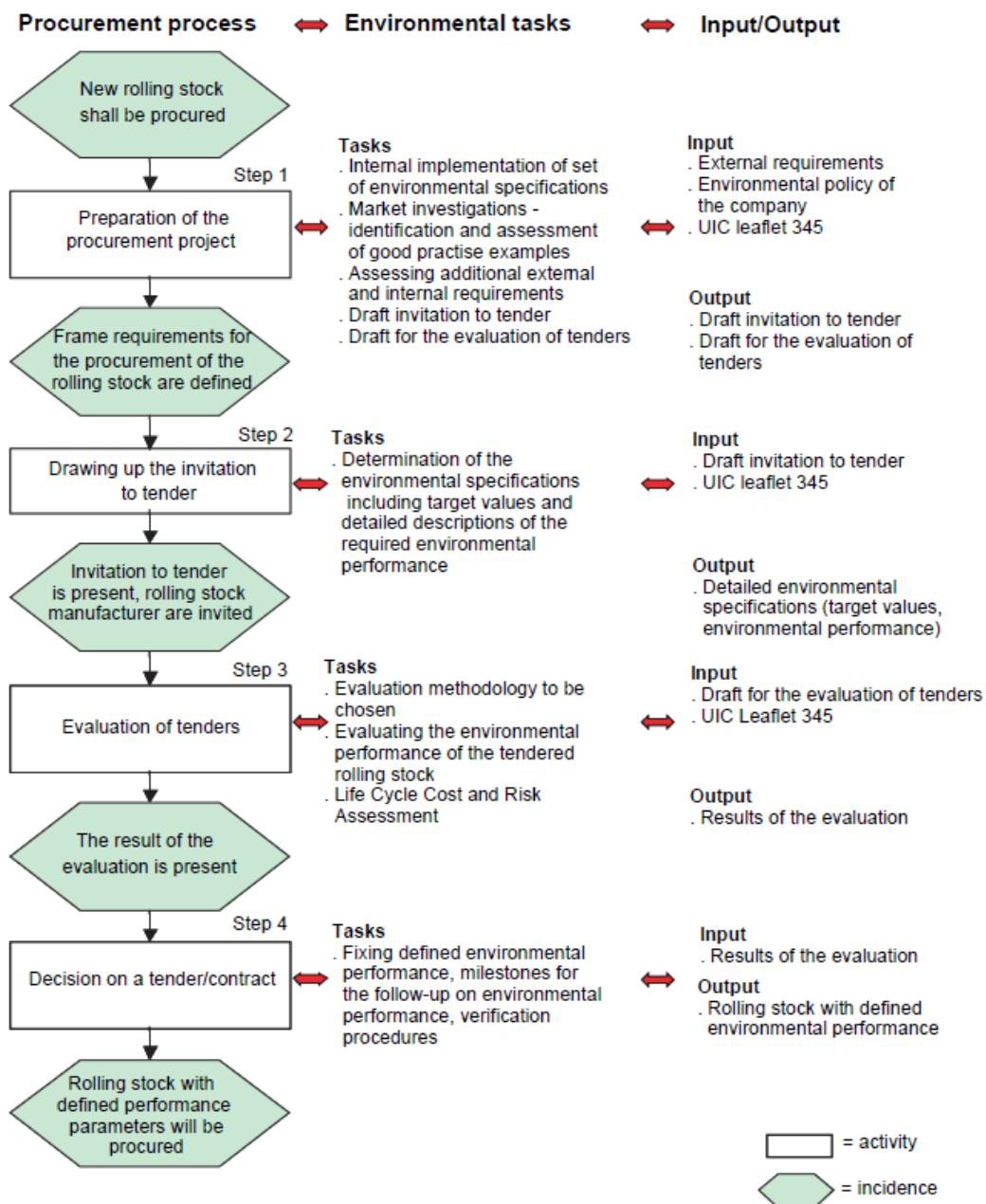

Source: UIC 2006

The Leaflet 345 suggest the following evaluation phases for the evaluation of tenders for new rolling stock and even for refurbishment or upgrading.

Figure 69 Strategy for the evaluation of environmental aspects in tenders for new rolling stock and refurbishment or upgrading

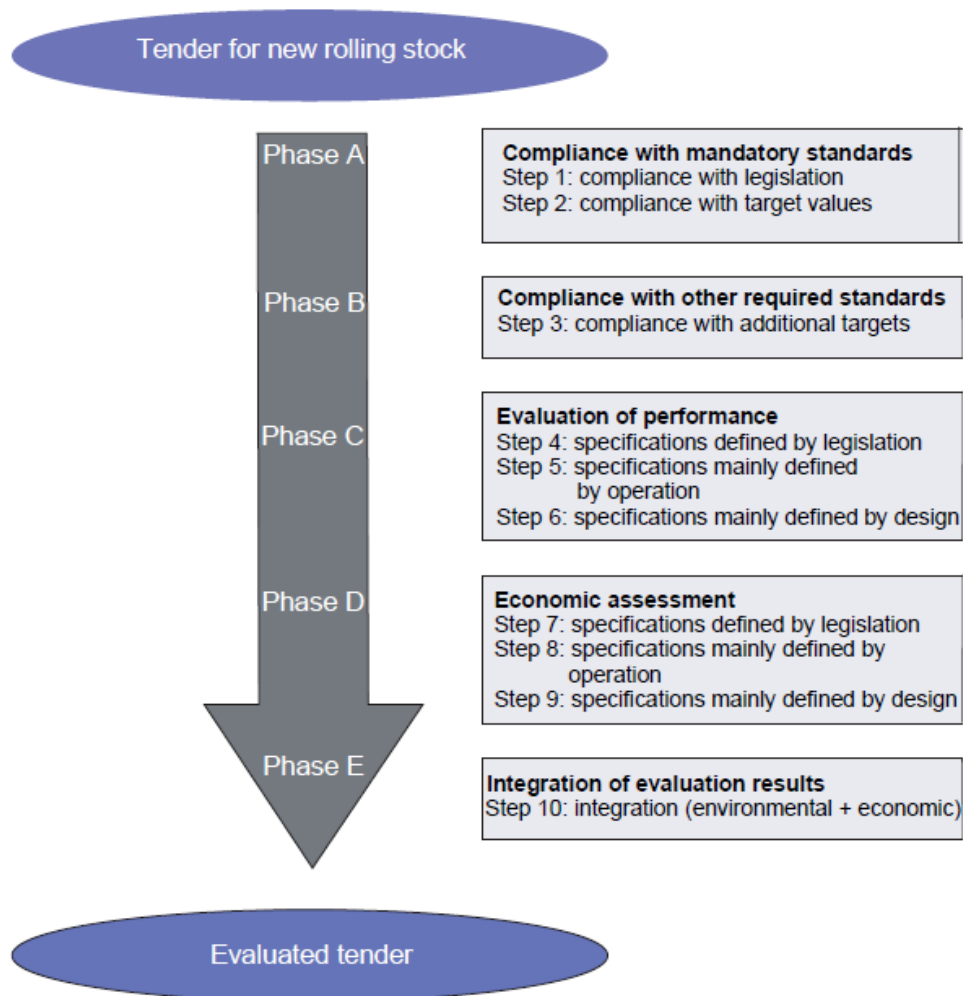

3.7.2 Uic leaflet 345 and its application and evolution

Beginning of 2007 a survey among UIC members has been undertaken in order to learn more about the members' further needs in the field of eco-procurement and their practical experiences with the UIC Leaflet 345. The feedback from members showed that several members were already using or planning to use the Leaflet. In line with the results of this survey the dialogue between UIC and UNIFE, regarding eco-procurement has been intensified in 2007 and 2008.

3.7.2.1 Summary of Uic Unife TEC REC 100 001

The Technical Recommendation 100_001 "Specification and verification of energy consumption for railway rolling stock" produced by UIC and UNIFE in 2010 is a voluntary standard for companies in the rail sector.

The general hierarchy within which a TecRec sits is, in order of prevalence:

- EN standards
- TecRecs
- UIC leaflets

TecRecs are managed by a joint UIC/UNIFE standards management group that meets on a regular basis to co-ordinate the process.

TEC REC 100 001 is applicable for the specification and verification of energy consumption of railway rolling stock. The criterion for the energy consumption of rolling stock is the total net energy consumed – either at pantograph or from the fuel tank – over a predefined service profile, which is either taken from the future operation of the train, or according to a standardised typical profile valid for the specific service category of trains. This will assure results directly comparable or representative for the real operation of the train.

The general purpose of Technical Recommendation is to provide the framework that will enable to generate comparable energy performance values for trains and locomotives on a common basis and thereby support benchmarking and improvement of the energy efficiency of rail vehicles.

The energy consumed over such a service profile shall be specified and verified as an input to life cycle cost (LCC) considerations. This requires a well-defined and harmonised methodology for specification and verification of the energy consumption. The selected approach has two steps:

- Simulation of the energy consumption of the train, for one or several specific train runs over a defined infrastructure under defined conditions.
- Measurements for the verification of this simulation under the same conditions as the simulation within acceptable tolerances.

Two different sorts of service profiles may be chosen:

- Individual service profiles based on data from a real railway line, normally one or several lines out of the railway network where the train will be operated. This will be the choice for trains built for a specific railway line or network, or for operators that want to know the exact consumption of a standard train under their operational conditions. Definitions of all applicable input parameters are given in annex A of this Technical Recommendation.
- Standardised, typical service profiles if applicable, for the following categories for passenger service:
 - Suburban
 - Regional
 - Intercity (inter-regional)
 - High speed

and for the following types of freight service:

- Mainline
- Shunting

In order to keep different characteristics, requirement and procedures manageable, the energy consumption for the whole train is handled separately:

- Traction equipment and auxiliaries necessary for traction without comfort systems
- Only comfort systems (for standstill and parking mode)

The TecREc show how to define the infrastructure and the operational and environmental conditions for both simulations and verification tests.

The infrastructure is defined by the following characteristics:

- Longitudinal profile
- Speed profile
- Curves
- Tunnels
- Electric power supply system
- Diesel fuel oil specifications

In the procurement process, the characteristics listed below are set by the infrastructure owner.

For operation two main phases of a train are considered further divided into other subsections:

- In-service operation mode
 - Train and propulsion system
 - Timetable
 - Pay load
 - Driving style
 - Regenerative braking
 - Comfort functions (in-service)
- Out of service mode
 - Pre-heating and pre-cooling
 - Cleaning of trains
 - Parking of trains (hibernating)
 - Environmental (ambient) conditions

These characteristics in the procurement process are provided by the train operator, while the rolling stock manufacturer is charged of simulations and documentation of results. Verification measurement and post processing phases are developed by the manufacturer with the confirmation of train operator.

Figure 70 TecRec characteristics in the procurement process

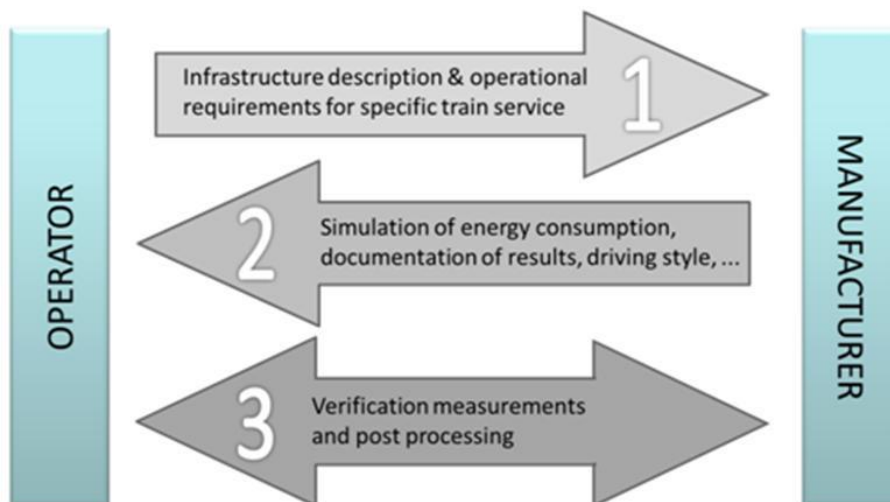

Source: UIC

In the Annex A of the TecRec definition of all necessary parameters are defined. The parameters are describing railway operation and rolling stock and they are divided in the clusters below, presented with definitions and measurement units:

- Infrastructure characteristics (I)
- Electric supply system characteristics (E)
- In service operation mode (S)
- Parked train service mode (P)
- Ambient conditions with seasonal changes (A)

Each parameter belongs to one category of either “required” or “optional”. In order to comply with Technical Recommendation all parameters labelled “required” shall be applied and specified. Parameters labelled “optional” may be applied and specified upon decision by the user.

3.7.2.2 TS 50591:2013

The TECREC 100.001 was offered to CENELEC TC9X on September 2011 as input for standardisation on December 2011. The working group WG11 started the conversion of the TECREC100.001 into a Technical Specification on January 2012. The TS 50591:2013 has been adopted in August 2013 and published in the 31st of January 2014. The actual process of transforming the TecRec/Technical Specification into the European standard EN 50591 has started in 2015 and it will be continued over the next years.

3.7.3 Environmental Report of Railway

From nineties onward it has become widespread the reporting activity of environmental and social performance, in particular between big companies and multinational. The Corporate Social Responsibility (CSR) is a new integrated approach to the environmental, social and economic aspects, defined as "...the duty of every corporate body to protect the interest of the society at large. Even though the main motive of business is to earn profit, corporates should take initiative for welfare of the society and should perform its activities within the framework of environmental norms..."¹⁵ The reporting activities could provide internal and external benefits for companies and organizations as shown in the table below.

Table 12 Internal and external benefit from CSR

INTERNAL BENEFIT	EXTERNAL BENEFIT
<ul style="list-style-type: none"> • Increased understanding of risks and opportunities • Emphasizing the link between financial and non-financial performance • Influencing long term management strategy and policy, and business plans • Streamlining processes, reducing costs and improving efficiency • Benchmarking and assessing sustainability performance with respect to laws, norms, codes, performance standards, and voluntary initiatives • Avoiding being implicated in publicized environmental, social and governance failures • Comparing performance internally, and between organizations and sectors 	<ul style="list-style-type: none"> • Mitigating – or reversing – negative environmental, social and governance impacts • Improving reputation and brand loyalty • Enabling external stakeholders to understand the organization’s true value, and tangible and intangible assets • Demonstrating how the organization influences, and is influenced by, expectations about sustainable development

Since the CSR reporting is developed internally by the organizations themselves and covers very sensitive topics, it has quickly emerged the need for some form of accreditation and certification from third parties. For this reason, a large number of methodological standard have been created at the international level, that translate into guidelines that an organization should follow to properly identify issues (environmental, economic and social) on which to report, the most appropriate indicators, objectives and targets, and to start a process of stakeholder engagement through a maximum transparency path.

AA1000 Accountability Principles Standard

The AA1000 Accountability Principles Standard is a product of an approach developed in the mid-90s, focused on a series of simple rules to follow for good reporting of corporate sustainability. In particular AA1000APS is articulated through three general reporting principles:

- Inlusiveness: individuals should be able to have their say with regard to decisions which can have impacts on them;

¹⁵ "Corporate Social Responsibility" Lord Holme and Richard Watt, 2013

- materiality: the decision-makers should identify clearly and transparently the topics considered relevant;
- representativeness: an organization should be transparent about the actions undertaken.

Global Compact

The Global Compact is an initiative launched by the UN in 2000 which was signed by a number of organizations, starting with the large multinationals. These have signed a series of general rules aimed at protecting the environment, the defense of human rights at the appropriate working standards for its employees and the fight against corruption. These rules are reflected in the following 10 principles:

1. support and respect the protection of internationally proclaimed human rights within their spheres of influence;
2. make sure that they are not even indirectly complicit in human rights abuses;
3. uphold the freedom of association and the effective recognition of the right to collective bargaining;
4. the elimination of all forms of forced and compulsory work;
5. the effective abolition of child work;
6. the elimination of all forms of discrimination in respect of employment and occupation.
7. support a precautionary approach to environmental challenges;
8. undertake initiatives to promote greater environmental responsibility;
9. encourage the development and diffusion of technologies that respect the environment.
10. work against corruption in all its forms, including extortion and bribery.

Integrated Reporting

The Integrated Reporting (IR) is a recent initiative by a gathering of regulators, investors, companies, regulators, professionals working in the accounting and NGO sector. The aim is to promote integrated reporting can show primarily to financing partners of an enterprise the ability of the same to create value. For this reason in 2013 it was proposed a framework that defines the basic concepts and principles of IR-guided, and the general content of an integrated report.

Global Reporting Initiative (GRI)

The Global Reporting Initiative (GRI) provides the world's most widely used standards on sustainability reporting and disclosure with thousands of reporters in over 90 countries. In fact, 92% of the world's largest 250 corporations report on their sustainability performance. The GRI is based on a set of guidelines, some dedicated specifically to certain types of businesses, which provide a practical tool for the selection of topics to be treated, the choice of indicators and targets as well as the stakeholders to be involved in the reporting process. As well as other reporting standards, it provides for external certification processes of the quality and conformity of the product with the reporting guidelines. In May 2013, a new version of the guidelines "GRI-G4" has been presented and the key enhancements included in G4 are:

- Up-to-date Disclosures on governance, ethics and integrity, supply chain, anti-corruption and GHG emissions
- Generic set of Disclosures on Management Approach
- Two "in accordance" criteria options, both focused on material Aspects
- GRI Content Index offering a transparent format to communicate external assurance
- Technically reviewed content and clear Disclosure requirements

- Detailed guidance on how to select material topics, and explain the boundaries of where material impacts occur
- Flexibility for preparers to choose the report focus
- Flexibility to combine with local and regional reporting requirements and frameworks
- Up-to-date harmonization and reference to all available and internationally-accepted reporting documents
- Overview tables, summaries and quick links to specific Guidelines' components
- Complete glossary, reference lists, and visual guidance

3.7.3.1 A study case of environmental report of railway – Ferrovie dello Stato Group (Italy)

There are no specific standards for the sustainability reporting of the railway sector, which usually are developed using the same guidelines for sustainability reports of big companies. This report analyses the case of *Ferrovie dello Stato Group* (Italy), considered a best practice of sustainability reporting in Europe. The new approach to sustainability of Ferrovie dello Stato (FS) Group permeates the full organizational structure ensuring integration of environmental, social and economical aspects within strategic business decisions.

Figure 71 Vision of FS Group



Source: "The FS Group approach to sustainability" Presentation by Lorenzo Radice, FS Group – UIC Wien Conference 2016

- **Economical commitment:** Being leader in the field of mobility by promoting quality and efficiency of transport and infrastructure services.
- **Social commitment:** Being a leading actor of integrated mobility promoting, through a virtuous business model, an inclusive and fair society.
- **Environmental commitment:** Being pioneers in developing and implementing large-scale integrated mobility solutions helping to regenerate natural capital

The FS Group strategic plan focused on four main key-areas, and for each one of them the main objectives are outlined as follows:

Table 13 FS Group sustainability strategic plan

<p>Environment</p>	<ul style="list-style-type: none"> • Energy efficiency of railway and passenger transport: losses reduction in electric substations, eco-drive, on-board energy meter, smart parking, new buses; • Energy efficiency in stations and real estate: LED technology, energy improvement of services; • Reduce environmental impacts of energy supply: PV system, micro-generation, certified sustainable energy; • Optimization of utilities: electricity, water, methane, etc.
<p>Safety</p>	<ul style="list-style-type: none"> • Reduce the number of injuries; • Reduce frequency of injuries (n. injuries per 1000 workers).
<p>Community</p>	<ul style="list-style-type: none"> • Renovation of real estate and train stations for social purposes; • Promote realizations of greenways.
<p>Human Resources</p>	<ul style="list-style-type: none"> • Development and fostering of key people (graduates, managers, etc.); • Support the professional grow of people based on equity, values and transparency; • Diversity management and gender gap reduction; • Employer branding: development of attractiveness.

Source: “The FS Group approach to sustainability” Presentation by Lorenzo Radice, FS Group – UIC Wien Conference 2016

The FS Group has developed a specific and strong governance system to achieve the goal expected by the sustainability plan. The Sustainability Committee includes the main operating companies of the Group and the central divisions that will ensure the control of the three dimensions of sustainability. The CEO appoints the Committee that consists of the President and 8 permanent members. Permanent members of the Committee are:

1. CEO of FS Italiane, as the President;
2. CEO of Trenitalia; CEO of RFI;
3. Director of Strategy, Planning and Sustainability – FS SpA;
4. Director of Human Resource and Organisation – FS SpA;
5. Director of External Communication and Media – FS SpA;

6. Director of Finance and Control and Asset – FS SpA;
7. Director of Administration, Budget and Tax – FS SpA;
8. Head of Sustainability.

The Sustainability Committee assures value creation for all the internal and external stakeholders, with respect to the sustainable development principles:

Mission

- Guarantee the integration of social and environmental aspects into the strategies of the Group as well as the promotion of principles and values of sustainable development with respect to the expectations and needs of all the stakeholders.

Responsibilities

- drawing up the Group vision, in compliance with the environmental and social dimensions along with the business, to be approved by the Board of Directors of FS;
- define long-term objectives and action plans, as per the Group vision, to be approved by the Board of Directors of FS;
- ensure the elaboration of the long-term objectives in short / medium term objectives to be integrated in the business plan;
- evaluate the Group sustainability performance and resolve any critical issues, through the establishment of inter-companies work tables;
- ensure stakeholder dialogues through engagement processes;
- ensure the dialogue with Ethic, Investment and Equal Opportunities Committees, to manage potential risks and opportunities.

The specific sustainability governance of FS Group includes also a management system in order to promote, lead and monitor the integration of sustainability tasks in business processes of the Group.

Figure 72 FS Group management system for the sustainability governance

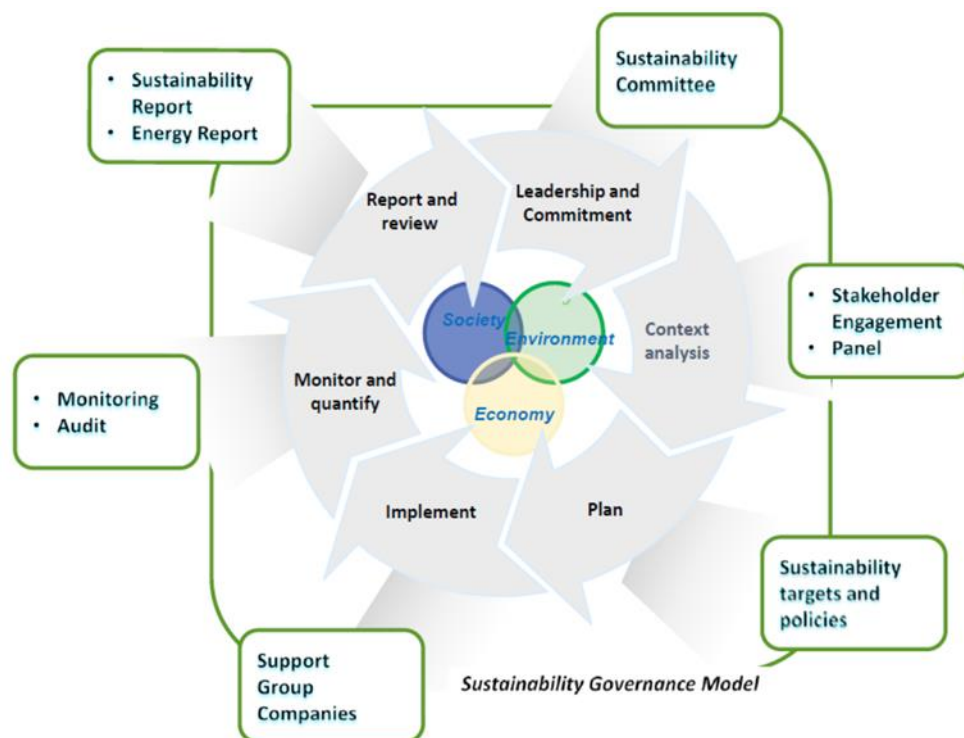

Source: “The FS Group approach to sustainability” Presentation by Lorenzo Radice, FS Group – UIC Wien Conference 2016

3.7.4 Ecopassenger and EcoTransit

Ecopassenger and EcoTransit are two internet tools developed to calculate energy consumption and emissions of pollutants into the atmosphere, according to how cargo and passengers are transported (by air, train, ship or car).

The procedure at the basis of EcoTransit was developed by the German Institute for Research on Energy and the Environment (IFEU - Institut für Energie und Umweltforschung) in Heidelberg, Rail Management Consultants GmbH (RMCon) and IVE mbh as part of a research project deriving from an initiative by a number of European Rail Carriers including Trenitalia. With regard to EcoPassenger, the relative system of calculation was developed by the Union Internationale des Chemins de fer (UIC), verified by the Institute for Research on Energy and the Environment in Heidelberg (Germany) and approved by the European Environmental Agency and the European Commission. This method was also verified by “Ente per le Nuove tecnologie, l’Energia e l’Ambiente” (ENEA – Organisation for New Technologies, Energy and the Environment) in Italy.

The parameters provided by this model regard consumption/emissions of:

Energy - this includes direct energy consumption by a vehicle and the production and distribution processes entailed

- Carbon Dioxide
- CO₂ - equivalent (valid only for EconTransIT)
- Nitrogen Oxide
- Non-methane Hydrocarbons
- Overall Powder Emissions
- Sulphur Dioxide (valid only for EconTransIT)

These parameters are calculated per passenger through Ecopassenger, whereas they are calculated according to ton of cargo or by TEU through EcoTransIT.

Both these software programmes are based on a databank comprising specific values for each country, such as infrastructure, orographic set-up and domestic energy mix, as well as values common to all countries such as emissions and energy consumption in various models of lorries, trains, ships and aircraft.

How EcoTransIT works:

In view of the model’s extreme complexity, this application ensures highly-customised questions to allow definition of the following:

- nature of cargo: heavy or light, liquids or solids, unpackaged or in containers, etc.;
- means of transport: lorries, trains, aircraft, ships or river barges;
- means of transport: load size/capacity for each vehicle (e.g. 20-ton lorry, 1,000-ton train or specific aircraft model);
- category of emissions: standard for emissions from specific lorry/ship/aircraft (e.g. Euro standard between 1 and 5 for road vehicles)
- load factor and empty trip factor: percentage use with respect to load factor and trip factor when empty (e.g. the average load factor of lorries with light cargo is 30% lower on average and 10% of light cargo trucks return empty).

Once the destination and departure have been set, the model uses the worldwide database of roads and motorways, railway networks, ports, airports and rivers.

There is generally a higher concentration of roads than railway lines or rivers. All infrastructural networks are connected and the programme can change from one network to another any time it is needed to transport cargo from the departure to the destination.

Figure 73 Screenshots from EcoTransIT – Calculation Parameters

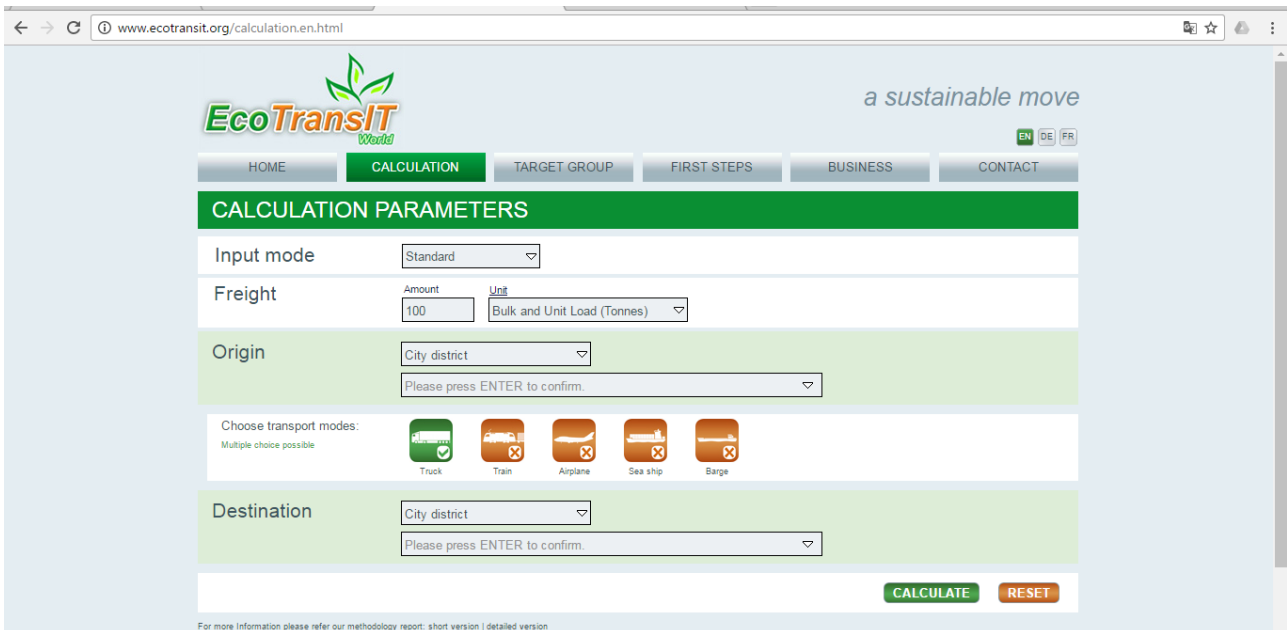

Source: EcoTransIT website

Figure 74 Screenshots from EcoTransIT – Results

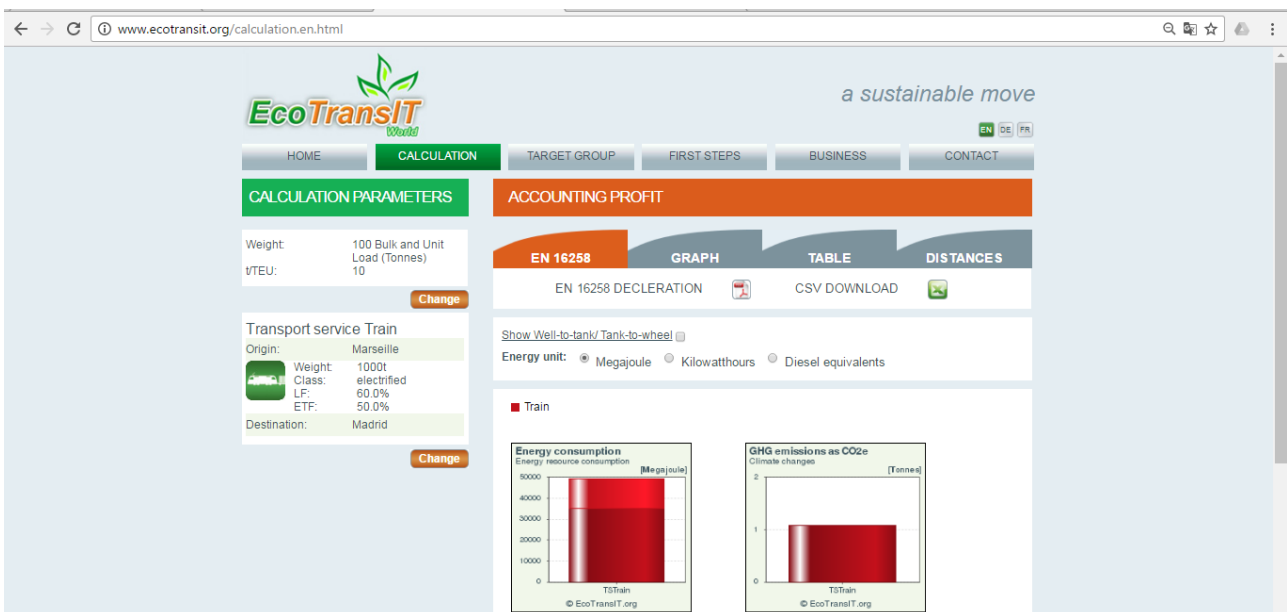

Source: EcoTransIT website

How Ecopassenger works:

The first step in applying this model entails choosing the relative departure and destination. Using this information, the model establishes the shortest route for each means of transport, combining various means if necessary (e.g. taxi to/from the airport).

Train journeys are calculated according to train timetables in force in various countries and regularly updated by infrastructure managers, whereas flights are calculated according to the distance between the airports as the crow flies within a range of 250 km as the crow flies with respect to departure and arrival.

Finally, car journeys are calculated according to the network of roads and motorways in each country using navigation software similar to those available on the market.

Once the journey has been established, energy consumption and emissions into the atmosphere for each of the three means of transport are calculated. Energy consumption and specific emissions from rail carriage are differentiated according to service type (High Speed, Intercity or Regional) and engine type (electric or Diesel). Prompt calculations are made for countries that apply specific emission factors for each service and engine type, otherwise European averages are used.

Energy consumption and specific emissions for transport by road vary considerably according to the category of vehicles taken into account (compact, medium and luxury), type of fuel used (petrol, diesel, LPG), emission standard (Euro 1 to 5) and type of journey involved (motorways, suburban and urban roads). There is no specific information for this means of transport in various countries, therefore the average car pool in Europe is used as a reference.

Energy consumption and specific emissions for air travel are calculated according to consumption/emissions for the most popular aircraft used on European flight routes (Airbus 320 and Boeing 737). Furthermore, this model can also take into account (using the RFI-Radiative Forcing Index application) the fact that a number of pollutants emitted at high altitude have a higher climate-changing effect than those emitted on the ground.

Figure 75 Screenshots from Ecopassenger – Route choice

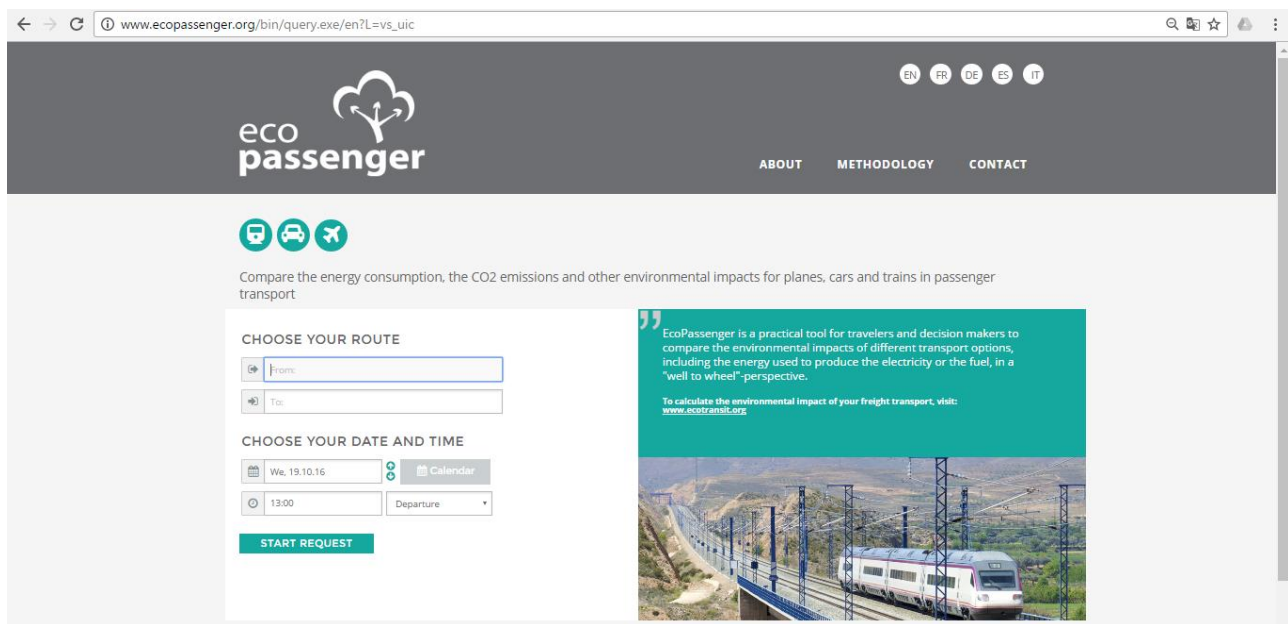

The screenshot displays the Ecopassenger website interface. At the top, there is a navigation bar with the logo and language options (EN, FR, DE, ES, IT). Below the navigation bar, there are three icons representing train, car, and plane. The main content area features a form titled "CHOOSE YOUR ROUTE" with fields for "From:" and "To:". Below this, there is a section titled "CHOOSE YOUR DATE AND TIME" with a date selector showing "We, 19.10.16" and a time selector showing "13:00". A "START REQUEST" button is located at the bottom of the form. To the right of the form, there is a teal box with text: "EcoPassenger is a practical tool for travelers and decision makers to compare the environmental impacts of different transport options, including the energy used to produce the electricity or the fuel, in a 'well to wheel'-perspective. To calculate the environmental impact of your freight transport, visit: www.ecstransit.org". Below this text is a photograph of a high-speed train on a bridge over a valley.

Source: Ecopassenger website

Figure 76 Screenshots from Ecopassenger – Results

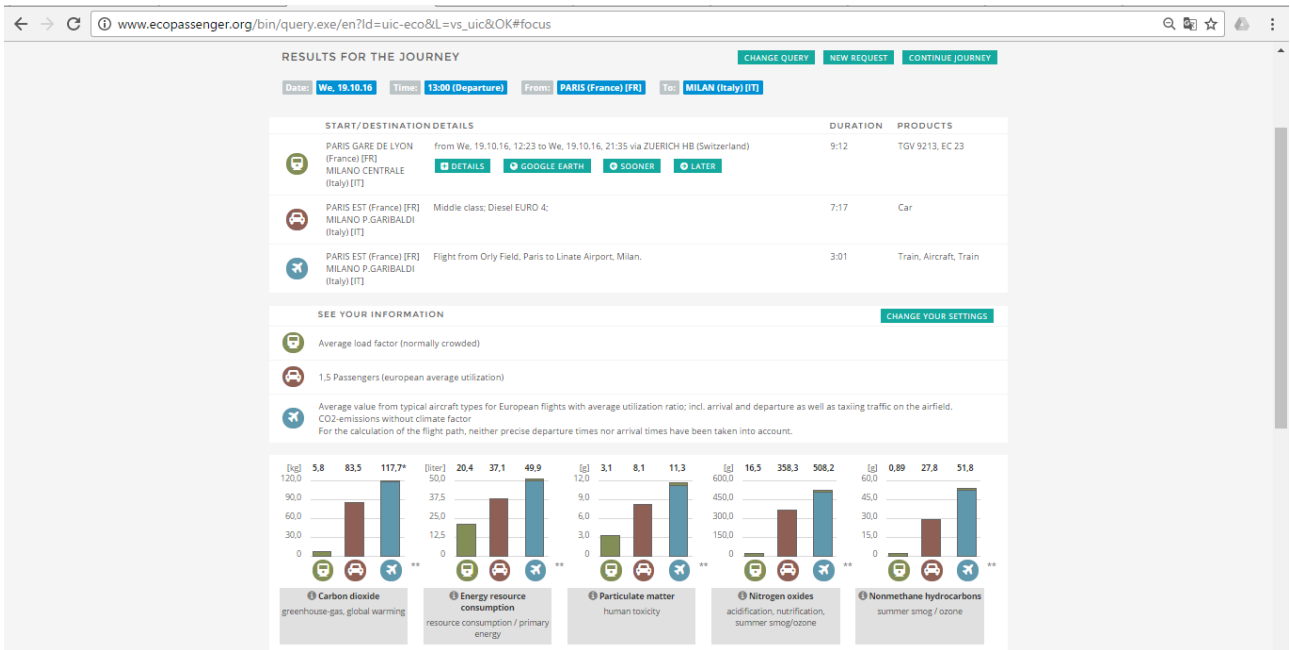

Source: Ecopassenger website

Conclusions: Energy and Environment R&D roadmap

As a conclusion of this report we will draw up a R&D Roadmap, centered on the environment issue, based on the EU funded FOSTER-RAIL project. This project (1 May 2013 till 31 April 2016) was properly launched in order to support the work of the European Rail Research Advisory Council (ERRAC) to the European Commission and to strengthen and support research and innovation cooperation strategies in the European rail sector.

The essence of the FOSTER-RAIL roadmap, aligned with the ERRAC Strategic Rail Research Innovation Agenda (SRRRIA), is to develop the railway sector in Europe for the decades to come to make it sustainably competitive and to improve overall transport efficiency in Europe.

To boost rail's market share dramatically, the European Railway System need to leverage its basic advantages and between them, sustaining and further developing the environmental friendliness of rail, is one of the main objective.

To make the rail transport even more environmentally friendly in the future a certain amount of long-term research is required. These technologies are probably not ready to use in the immediate future but are necessary to ensure the initiation of a paradigm shift for rail as a preferred transport mode for passengers and freight in the next 30 years.

The outcomes of the FOSTER-RAIL project are Ten Technology Roadmaps showing the way ahead for a successful and sustainable railway market. In this framework, the R&D Roadmap reported below summarize in a unique Roadmap the different issue addressed in this report.

From a technological perspective, innovation is expected to produce more energy and resource efficient systems for infrastructure, rolling stock, and operations.

Infrastructure

Infrastructure covers energy distribution, energy generation and energy usage, especially at stations. Technology and innovation is required for:

- SMART Grid: Delivery of managed energy distribution systems that maximize efficiency and report, in a qualitative manner, are required to in order to demonstrate effective energy usage thus a Pan-European approach to SMART Grid technology and innovation is envisaged.
- Advanced Traction Energy Supply : Sustained and efficient Energy Supply for rolling stock traction is critical for railway operations and innovative and technological advances in electrical energy distributions, development of higher voltage systems is anticipated, plus an increasing ability for regenerated energy to be returned to the grid.
- Non-Traction Energy: Innovative ways are required to support the belief that there is considerable potential for locally generated and renewable energy resources to be used to power local non-traction systems, especially at stations and terminals; further, excess energy could be used/sold for local consumption.

Rolling stock

Rolling Stock consumes a significant proportion of the energy used by the railway and needs to continuously improve its efficiency and effectiveness in converting effectively energy resources into traction and on-board services.

The associated three key areas for technology and innovation identified are:

- Lighter Trains: the use of mechatronic systems, lighter materials and innovative approaches to weight reduction are envisaged
- Hybrid Traction: innovative technology applied to improving diesel fuel engines is required, along with the development and incorporation of hybrid energy solutions that maximise operational

effectiveness. Energy resources, especially their resilience and availability for traction drive are a focus for innovation and in reducing the rolling stock contribution to environmental impact

- EE Auxiliaries: Technology and innovation to reduce energy consumption of on-board systems (heating, lighting, etc.) are needed.

Operation

The key requirement for Operations and Management is to increase and steadily improve management of rolling stock, enabling it to be driven more efficiently and in an eco-friendly manner, specifically:

- Traffic Flow Management: Innovative ways for energy reduction and environmental impact through integrated traffic management
- Communications between TMS & DAS : Develop systems that increase the energy efficiency of driving through DAS supported driving and real time links with TMS

Three areas for technology and innovation have been identified to Energy and Efficiency Support and Communication:

- Noise and Vibration: There is a need to reduce noise and vibration levels across the railway and reduce associated impact on the environment. This is a pre-requisite for 24 hour operation
- Energy & Carbon reporting : The European railway needs to measure its energy efficiency and effectiveness in coherent and uniform ways to enable it to consider areas for action, as well as understanding its contribution to environmental issues
- Climate Change: Increased incident of weather extremes and climate change will impact the railway; technology and innovation is necessary to provide climate resilience and the ability to operate and recover from extreme weather related events.

Technologies that protect infrastructure and trains from heat, water (rain, snow, ice, flood, etc.), and allowing a degree of end-to-end journey provision are sought.

Table 14 R&D Roadmap

AREA OF ACTION		Key environment driver involved	2016	2020	2025	2030	2040	2050	
Infrastructure	Electrification	Energy	Further electrification						
	Energy storage	Energy		Battery Equipment on board to reach non electrified area			Energy harvesting		
	Regenerative breakings	Energy		Regenerative breakings			Regenerative breakings - 10 - 20% specific energy		
	Catenary	Energy							
	Design of railway distribution networks	Energy		Smart Grids					
	Greenings the energy mix	Energy		Renewable Energy Production					
	Modelling tools to analyse whole-life whole-system energy and carbon impacts	Energy, Carbon, Materials	Decision support tools for sustainable design and energy efficiency	Decision support tools for sustainable design and energy efficiency	Decision support tools for sustainable design and energy efficiency	Develop tools to support whole life approach and energy efficiency			
	Improved design and materials to increase track resilience and cost efficiency	Energy, Carbon, Materials	Optimised track	Optimised track	Optimised track	New resilient materials and improved conventional designs etc			
			Improved design for climate change resilience	Improved design for climate change resilience	Improved design for climate change resilience	Self healing or extreme long life materials for	Self healing or extreme long life materials for		
	Control, Command and Communication implementation	Energy, Carbon	Cost-effective standard design, test, installation and maintenance of signalling infrastructure and onboard equipment	Cost-effective standard design, test, installation and maintenance of signalling infrastructure and onboard equipment	Need to have an open architecture to reduce energy consumption cost-effective design				
Optimise environmental and sustainable impacts of the life cycle of subcomponents	Energy, Carbon, Materials				Design procurement, installation, maintenance, operations and disposal				
	Energy, Carbon				Political approach and econ. assessment of feeding kinetic energy back to the public grid				
Rail roughness maintenance	Noise and vibrations	Develop acoustic grinding		Validate acoustic grinding in operation	Optimisation		Management of the roughness growth		
Rolling Stock	Wheel roughness maintenance	Noise and vibration	Deployment of silent brake blocks						
		Noise and vibration	Develop acoustic wheel reprofiling		Validate acoustic wheel reprofiling in operation			Optimisation	
	Brake	Noise and vibration	Design of silent brake system (squel noise)	Design of less annoying brake system (squel noise)					
	Hotel load	Energy, Carbon, Pollutants	Deployment of more efficient fleet - 10 - 20 % specific energy	Deployment of more efficient fleet - 10 - 20 % specific energy					
	HVAC	Energy, Carbon, Pollutants							
	Mechatronics on running gears	Energy, Carbon			Mechatronics boogies			All electric auxiliary systems heat exchangers, (no compressed air)	
	Reducing vehicle life cycle costs	Energy, Carbon, Pollutants	Hybrid Traction : Multiple power sources including energy storage on-board						
		Energy, Carbon	EE Auxiliaries - Optimisation and development of intelligent management auxiliaries						
		Energy, Carbon	Future generation of power semi-conductors beyond SiC (Silicon carbide) e.g. diamond						
		Energy, Carbon	Innovative Propulsion - Implementation of hydrogen fuel cell of RAMS/LCC incl. the aspect of hydrogen production & storage						
Energy, Carbon		Energy and Environment - environmental friendly and energy efficient HVAC							
Environmentally friendly rolling stock with special emphasis in the reduction of the emission of noise and vibrations and mitigation of their impact	Energy, Carbon, Noise	Improved prediction methods and design solutions to reduce aero acoustics noise of high speed trains							
	Energy, Carbon, Noise	Reduction of N&V annoyance towards exterior							
Adapting/revisiting RS standards and norms to increase the competitiveness of the railway transport system	Energy, Carbon, Materials, Noise	Energy and Environment - Ecoprocurement specifications and harmonisation							
	Energy, Carbon, Materials, Noise	Eco-design label for rolling stock - Based on key criteria covering significant environmental aspects : Energy-CO2, Materials, Noise							
	Energy, Carbon, Materials, Noise	Pursuing virtualization of certification/homologation							
Operation	DAS		DAS installed on High Speed Fleet -10% specific energy			DAS installed on High Speed Fleet -10% specific energy			
	Parked trains								
	Traffic flow management								

TRL Technology Readiness Levels
Research
Development
Technology applications for the rail system as a whole

Reference

- ADB 2015, *Improving Energy Efficiency and Reducing Emissions Through Intelligent Railway Station Buildings*, Asian Development Bank, Manila 2015
- Bombardier 2010, *ECO4 Technologies – Leading the way in total train performance*. Bombardier. Internet: http://www.bombardier.com/content/dam/Websites/bombardiercom/supporting-documents/BT/Bombardier-Transport-ECO4_Overview-EN.pdf. Accessed September 25, 2015.
- C. Robinson (2011), *Roundup and birth defects: Is the public being kept in the dark?* Earth Open Source, 2011
- C.J. van Dijk & C. Kempenaar (2013), *Weed control on pavements: Inputs, costs and environmental impacts of weed control methods in The Netherlands and Flanders, Belgium*, Plant Research International, Wageningen, November 2013
- CER, 2014 "Rail Technical Strategy Europe", 2014.
- COMPAMED ZNA, *Comparison of Weed Control Methods Used to Manage Non-Crop Areas*
- DE VOS 2013, Paul de Vos, *Real noise reduction of freight wagon retrofitting, Supporting communication on noise reduction, Synthesis report, report nr. MD-AF20120302, UIC, Paris 2014* 2013
- DG INTERNAL POLICIES 2012, *Reducing Railway Noise Pollution, EU, Directorate General for Internal Policies, Brussels 2012*
- DieselNet 2016, *Emission standards - Internet: <https://www.dieselnet.com/standards/> Accessed: September 2016*
- EEA 2014, *Noise in Europe 2014, EEA report No 10/2014, European Environment Agency*,
- EPD-PCR, 2009 "Product Category Rule according to ISO 14025-2006 for rolling stock", 2009, latest version updated 2.11 in 2014.
- EU-CE, 2015 "Closing the loop - An EU action plan for the Circular Economy", Eu Commission, 2015.
- EU-ELV, 2000 "Directive 2000/53/EC on end of life vehicles", 2000.
- EU-WFD, 2008 "Directive 2008/98/EC on waste", 2008.
- IZT 2003, *EVENT Evaluation of Energy Efficiency, Technologies for Rolling Stock and Train Operation of Railways, Final Report, UIC, Berlin, 2003*
- IZT 2016, *Fleet scenarios, emission reduction & energy efficiency potentials - Presentation by Roland Nolte, UIC Wien Conference 2016*
- IZT/Macroplan 2012, *Study on Non-traction energy consumption and related CO2 emissions from the European railway sector, Final report, UIC, Copenhagen and Berlin, 2012*
- Jony 2014, *Energy Efficient Rolling Stock – Is dual hybrid the future? Energy Efficiency Days 2014, Antwerp. Internet: <http://www.energy-efficiency-days.org/spip.php?article19>. Accessed September 25, 2015.*
- MERLIN 2013 a, *Deliverable 1.1 Railway network key elements and main sub-systems specification, Merlin Project, 2013.*
- MERLIN 2013 b, *D1.2 Global consumption map and analysis, Merlin Project, 2013.*
- MG, 2014 "Recycling Guidelines of the Rolling Stock", Paper 62, *Proceedings of the Second International Conference on Railway Technology*, 2014 (and references therein).
- MG-1, 2014 "Rail vehicles recycling", *Computers in railways XIV*, 425, 2014 (and references therein).
- MÜLLER-BBMa 2014, *Measures on Rail Traffic Noise in the Europe, Input paper for the Interest Group on Traffic Noise Abatement, version 4, Interest Group on Traffic Noise Abatement (IGNA), Berne 2014*

MÜLLER-BBMB 2014, *Managing noise from parked trains*, UIC, Paris 2014

SBB 2015, *Personal Communication of UIC Sustainable Development Unit with SBB*. April 2015.

UIC 10th workshop on Railway noise, Paris 2016

UIC 2008, *Environmental Noise Directive Development of Action Plans for Railways*, UIC, Paris 2008

UIC 2008, *Process, Power, People - Energy Efficiency for Railway Managers*, UIC, Paris, 2014

UIC 2014a, *International Railway Statistics 2014*, Statistics Centre of the International Union of Railways, Paris.

UIC 2014b, *UIC Environmental Performance Database 2014*. UIC, Paris, 2014

UIC 2014c, *Energy and emission reduction drivers of European Rail sector*, Technical study, UIC, Paris, 2014

UIC 2014d, *Technical Report for Low Carbon Rail Transport Challenge Action Plan*, UIC, Paris 2014

UIC 2015 1990-2030 Environment Strategy Reporting System, 2015 Report – UIC, Paris 2015

UIC 2015, *UIC environmental Performance Database 2015* – UIC, Paris 2015

UIC 2015b, *UIC Environmental Strategy Reporting System – Methodology and Policy* - UIC, Paris 2015

Websites

CleanrD www.cleaner-d.eu

EC SHIFT 2 RAIL http://ec.europa.eu/transport/modes/rail/shift2rail_en.htm

Eco Passenger http://www.ecopassenger.org/bin/query.exe/en?L=vs_uic

ECORails <http://ecorails.eu/>

EcoTransIt <http://www.ecotransit.org/>

Energy efficiency days 2014 in Antwerp <http://energy-efficiency-days.org/>

Merlin Project website http://www.merlin-rail.eu/?page_id=60

Railenergy Project <http://www.railenergy.eu/keyperformanceindicators.aspx#KPI1>

STAIRRS www.stairrs.org

UIC Environment <http://www.uic-sustainability.org/spip.php?article36>

UIC Environment <http://www.uic-sustainability.org/spip.php?article36>

UIC Environment Strategy Reporting System <http://www.co2-data.org/>

UIC Environment Strategy Reporting System <http://www.co2-data.org/>



with the technical support of

